

Displacement flow diffusers

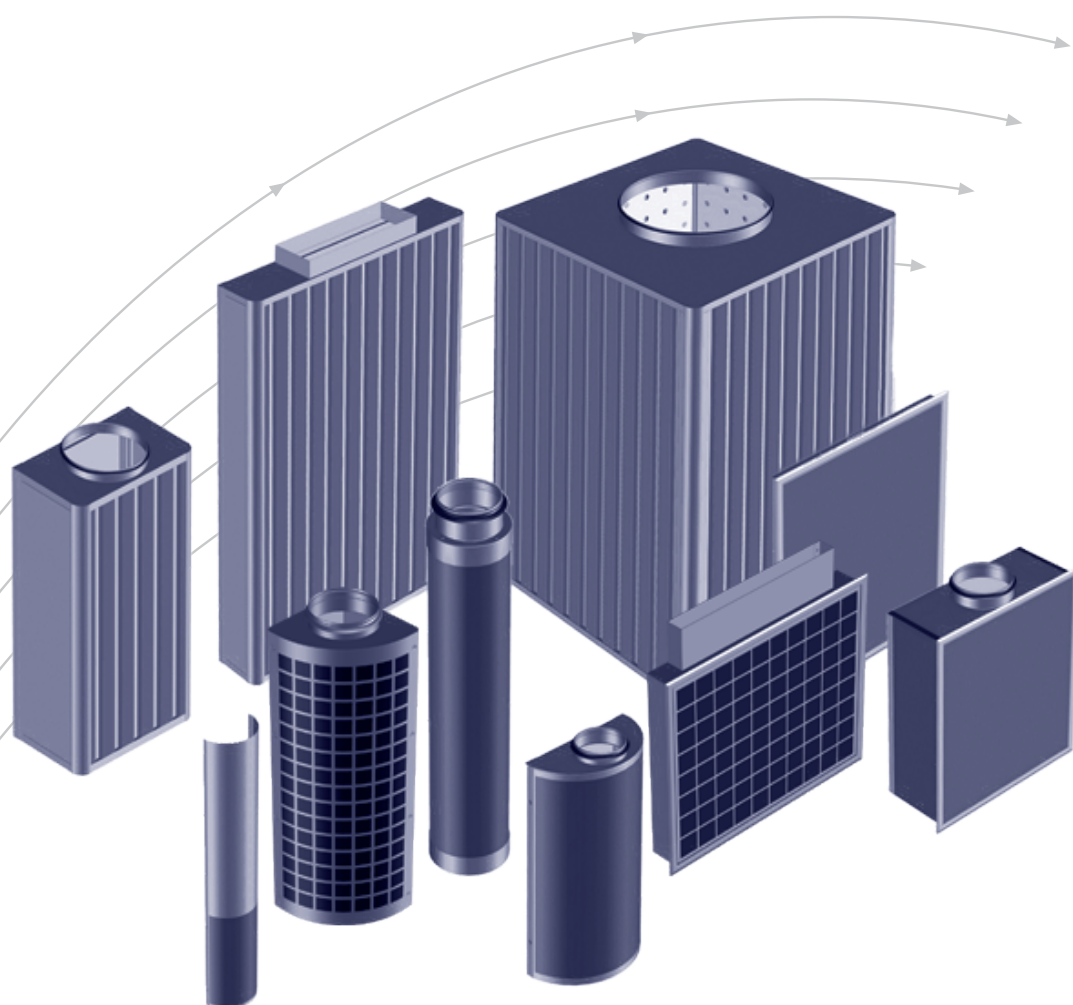

TROX[®] TECHNIK



The art of handling air

TROX HESCO Schweiz AG
Walderstrasse 125
Postfach 455
CH-8630 Rüti ZH

Tel. +41 55 250 71 11
Fax +41 55 250 73 10
www.troxhesco.ch
info@troxhesco.ch

Contents · Application · Safety instructions

Contents

Application · Safety instructions	2
Construction · Perforation · Principle of operation · Example of quick selection	3
Type QL-WE-Eo/ Type QL-WE-EO-K/	4 and 5
Type QL-WE-RO/ Type QL-WE-RO-K/	6 and 7
Type QL-WE-O/ Type QL-WE-O-K/	8 and 9
Type QL-WF-EO/ Type QL-WF-EO-K/	10 and 11
Type QL-WF-RO/ Type QL-WF-RO-K	12 and 13
Type QL-WR-RO/ Type QL-WR-RO-K/	14 und 15
Type QL-WH-RO/ Type QL-WH-RO-K/ Type QL-WH-RO/.../K Type QL-WH-RO-K/.../K	16-19
Type QL-WV-RO/ Type QL-WV-RO-K/ Type QL-WV-RO/.../K Type QL-WV-RO-K/.../K	20-23
Type QL-WS-RO/.../K Type QL-WS-RO-K/.../K	24 and 25
Type QL-BE-RO/ Type QL-BB	26
Type QL-WQT-RO-2/ Type QL-WQT-RO-3/ Type QL-WQT-RO-4/	27-29
Type QL-WFM...	30 and 31
Type QL-WFT-RO/ Type QL-WFT-EO	32 and 33
General technical information	34
Temperature conditions: Nomenclature	35
Temperature conditions: Comfort conditioning	36
Temperature conditions: Industrial applications	37
Displacement flow-extent of near zone	38-40
Flow rate control	41
Specification texts	42 and 43
Order details	44

IMPORTANT:

This leaflet lists only the most common standard sizes. Other dimensions are available on request.

Magnetic method for fixing the flat face plate on request.

Installation instructions are included with the diffusers.

Application

The TROX HESCO displacement flow diffusers have been developed specifically for air supply in displacement flow ventilation systems. A wide range of different shapes ensures that they can be effectively integrated into the interior design.

TROX HESCO displacement flow diffusers are used where good ventilation efficiency is very important, i.e. the lowest possible pollutant contamination in combination with optimum thermal comfort in work areas and occupied spaces.

Technical Data

This document is sufficient for a quick selection (see example below). For a detailed layout please use the calculation software „Easy Product Finder“ or ask one of our sales staff.

Safety instructions



CAUTION!

Risk of injury from sharp edges and corners, ridges and thin-walled sheet metal parts!

- Proceed carefully with all work.
- Wear protective gloves, safety shoes and protective helmet.



WARNING!

Danger from incorrect use. Misuse of the product may lead to dangerous situations.

The product must not be used:

- in areas subject to explosion hazards;
- in the open air without sufficient protection against weather effects;
- in atmospheres that may have a damaging and/or corrosive effect on the product due to scheduled or unscheduled chemical reactions.



CAUTION!

Damage to the product due to improper handling. Check the device for damage and contamination prior to operation!

Improper handling may lead to considerable material damage of the product.

- Do not use any acid or abrasive cleaning agents.
- Adhesives from sticky tape may lead to colour damage.
- Excessive moisture may lead to colour damage and corrosion.
- Use only cleaning agents, greases and oils that are expressly specified.



FLAME RETARDANT

Construction · Perforation · Principle of operation · Example of quick selection

Construction

TROX HESCO displacement flow diffusers in standard construction are made of galvanised sheet steel. The face plate is perforated with 3 mm holes. The visible areas are powder coated (RAL 9010). Other RAL colours are available on request. They are maintenance-free because they do not use filter material. Customised versions are available. Size tolerances ± 2.5 mm.

In the standard construction TROX HESCO displacement flow diffusers are supplied ready to install.

The special nozzles with integral air deflector scoops are in plastic (polypropylene).

Round circular spigots ≤ 400 mm with lip seal.

Standard perforation (QL-BE: see page 26)

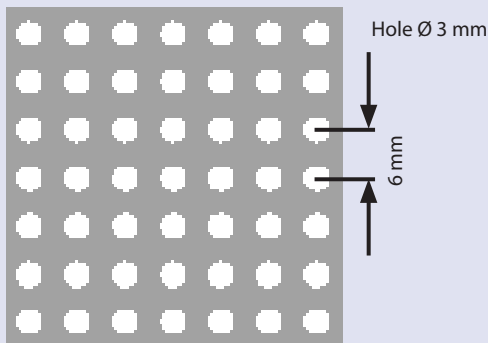

Perforation with checkered pattern

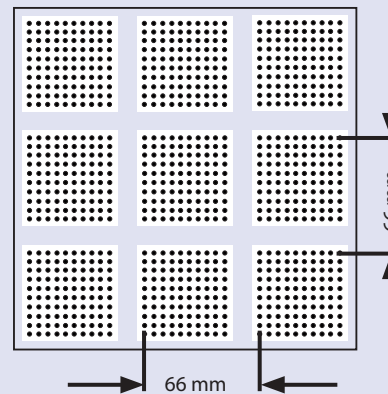

Example of quick selection

To simplify the process the data for the discharge velocities [m/s] and the sound power level L_w [dB(A)] are summarised in the following chart.

Nomenclature

- ‡ Flow rate
- v_0 Discharge velocity based on gross outlet area
- L_w Sound power level
- $v_0 = 0.10$ m/s
- $v_0 = 0.20$ m/s
- $v_0 = 0.30$ m/s
- $v_0 = 0.40$ m/s

m^3/h

m/s
dB(A)

Nozzles X30 and X60

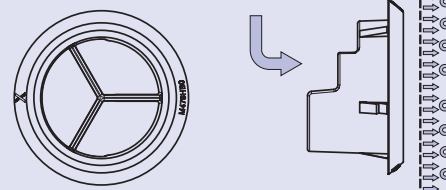

$$C1 \text{ for } \ddagger \text{ in } \text{m}^3/\text{h} > \Delta p = \left(\frac{\ddagger}{Cx} \right)^2$$

$$C2 \text{ for } \ddagger \text{ in } \text{l/s}$$

Example: Type QL-WH-RO/

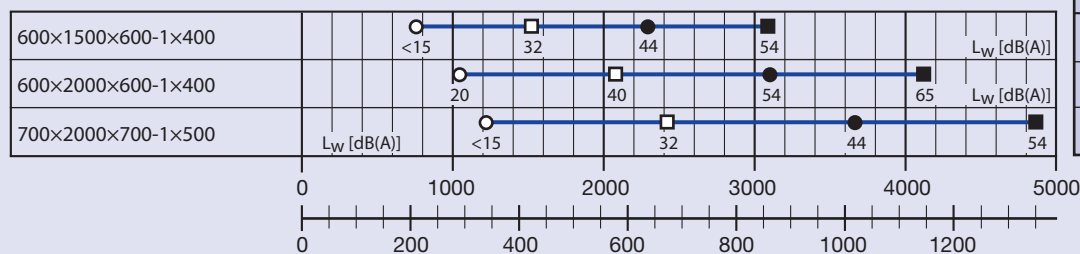

C1 m^3/h	C2 l/s
368	102.2
382	106.1
578	160.5

Technical Data

Type QL-WE-EO/

for installation in a wall, one way discharge

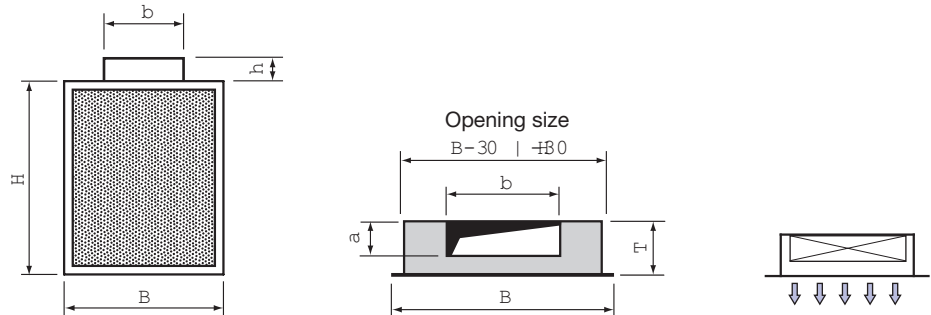
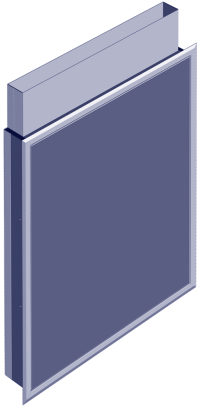

Dimensions Type QL-WE-EO/	B [mm]	H [mm]	T [mm]	b [mm]	a [mm]	h [mm]	Weight ca. [kg]
600× 300× 75-300× 45	600	300	75	298	43	100	6
600× 500× 75-450× 45	600	500	75	448	43	100	9
600× 700×115-400× 90	600	700	115	398	88	100	13
600×1000×115-450× 90	600	1000	115	448	88	100	18
900×1200×125-650×100	900	1200	125	648	98	100	31
1200×1200×125-900×100	1200	1200	125	898	98	100	41
900×1500×150-800×125	900	1500	150	798	123	100	39
1200×1500×150-900×125	1200	1500	150	898	123	100	51
1200×2000×200-900×160	1200	2000	200	898	158	100	67

Other dimensions on request.



B max = 1'200 mm H max = 2'000 mm
B max = 2'000 mm H max = 1'200 mm

Quick selection

Type QL-WE-EO/

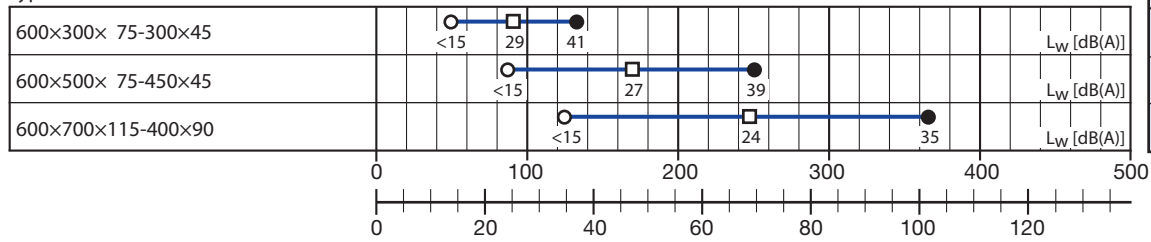

C1 m³/h	C2 l/s
26	7.3
48	13.4
83	23.0

Type QL-WE-EO/

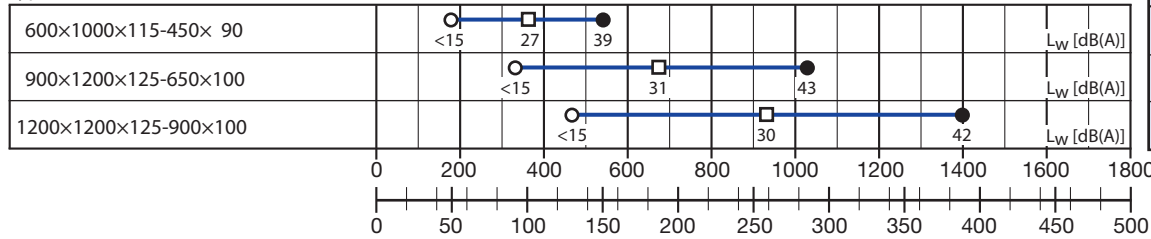

C1 m³/h	C2 l/s
102	28.4
173	48.1
243	67.5

Type QL-WE-EO/

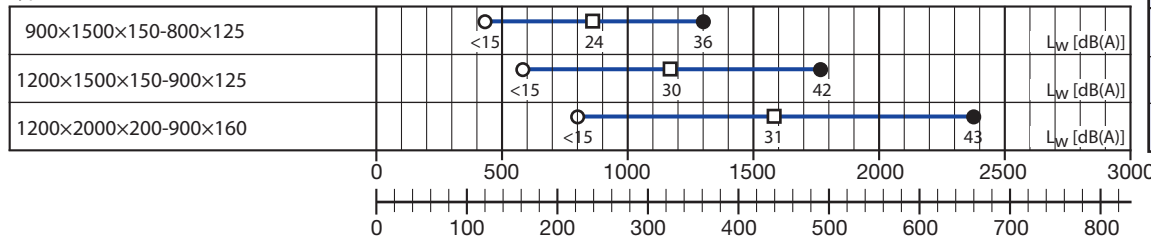

C1 m³/h	C2 l/s
269	74.7
305	84.7
399	110.7

Technical Data

Type QL-WE-RO/

for installation in a wall, one way discharge

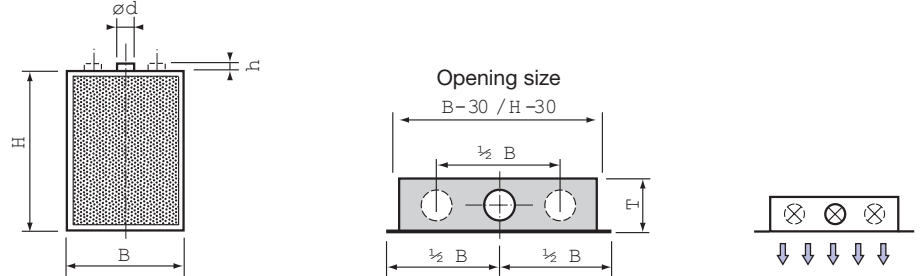
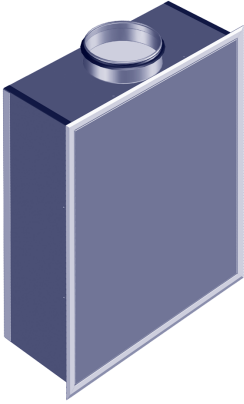

Dimensions Type QL-WE-RO/	B [mm]	H [mm]	T [mm]	Ød [mm]	h [mm]	1/2 B [mm]	Weight ca. [kg]
600x 300x160-1x125	600	300	160	1 x 123	50		7
600x 500x200-1x160	600	500	200	1 x 158	50		11
600x 700x250-1x200	600	700	250	1 x 198	50		15
600x1000x300-1x250	600	1000	300	1 x 248	50		22
900x1200x300-2x250	900	1200	300	2 x 248	50	450	37
1200x1200x300-2x250	1200	1200	300	2 x 248	50	600	50
900x1500x300-2x250	900	1500	300	2 x 248	50	450	48
1200x1500x350-2x315	1200	1500	350	2 x 313	50	600	60
1200x2000x350-2x315	1200	2000	350	2 x 313	50	600	80

Other dimensions on request.



B max = 1'200 mm H max = 2'000 mm
B max = 2'000 mm H max = 1'200 mm

Quick selection

Type QL-WE-RO/

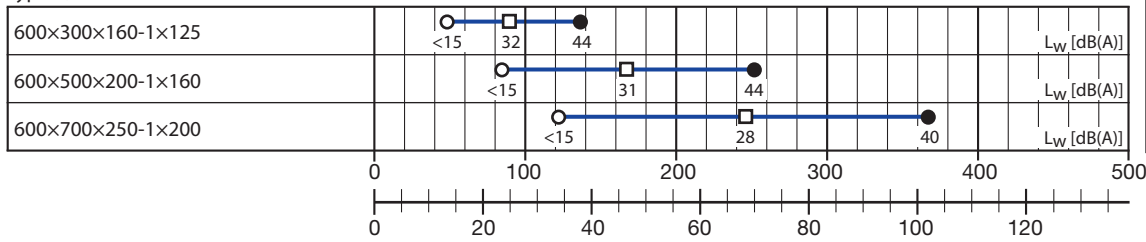

C1 m³/h	C2 l/s
22	6.1
41	11.4
67	18.5

Type QL-WE-RO/

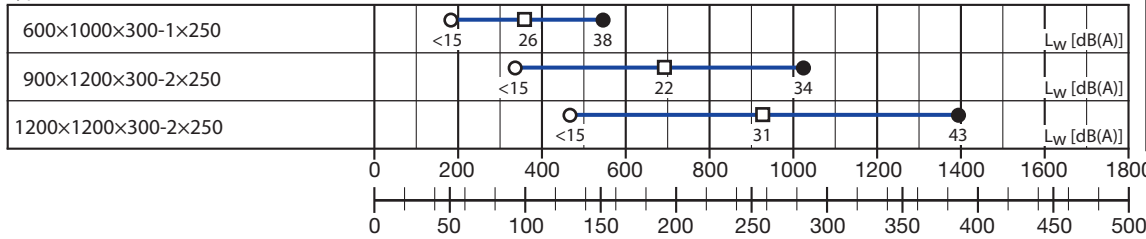

C1 m³/h	C2 l/s
108	29.0
234	64.9
234	65.0

Type QL-WE-RO/

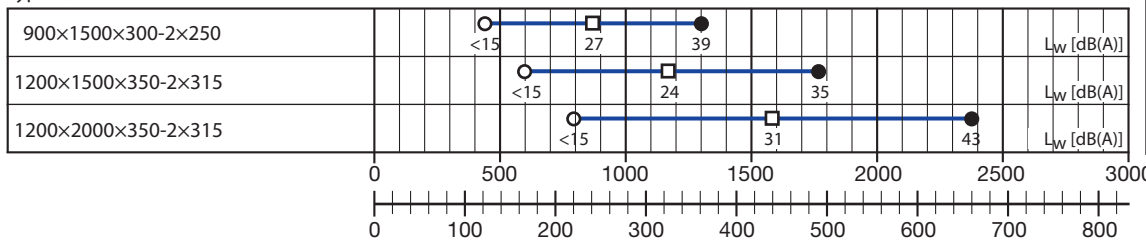

C1 m³/h	C2 l/s
243	67.4
376	104.3
397	110.3

Technical Data

Type QL-WE-O/

for installation in a wall, one way discharge, without plenum box

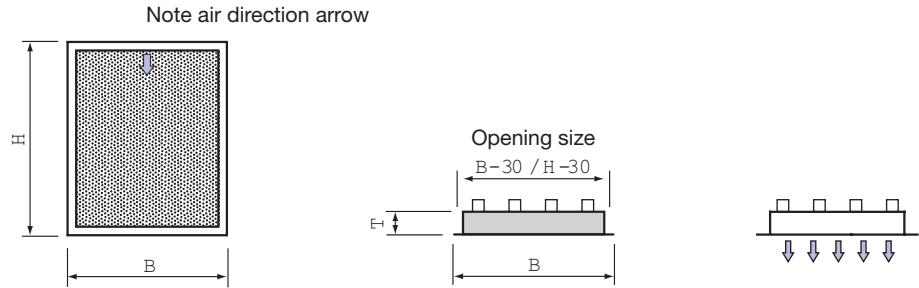

Dimensions Type QL-WE-O/	B [mm]	H [mm]	T [mm]	Weight ca. [kg]
600× 300×35	600	300	37	4
600× 500×35	600	500	37	6
600× 700×35	600	700	37	8
600×1000×35	600	1000	37	11
900×1200×35	900	1200	37	13
1200×1200×35	1200	1200	37	25
900×1500×35	900	1500	37	24
1200×1500×35	1200	1500	37	31
1200×2000×35	1200	2000	37	41

Other dimensions on request.



B max = 1'200 mm H max = 2'000 mm
B max = 2'000 mm H max = 1'200 mm

Quick selection

Type QL-WE-O/

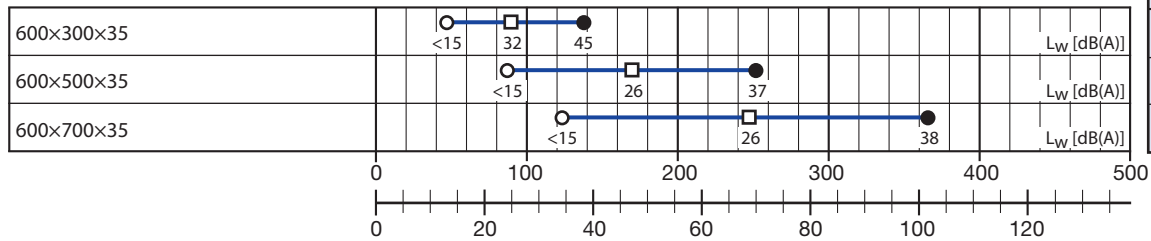

C1 m ³ /h	C2 l/s
22	6.0
51	14.1
73	20.1

‡ [m³/h]

‡ [l/s]

Type QL-WE-O/

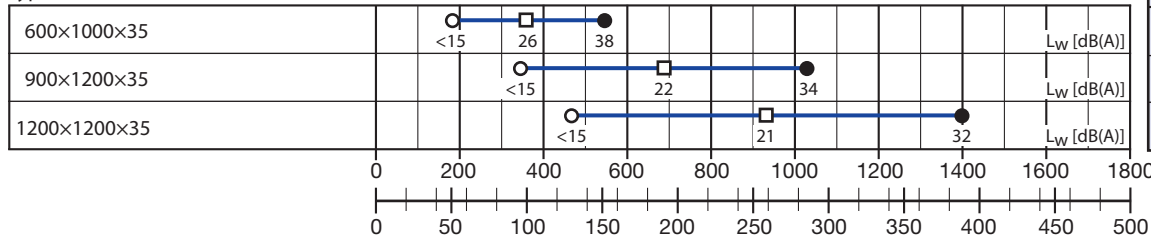

C1 m ³ /h	C2 l/s
107	29.7
234	64.9
334	92.8

‡ [m³/h]

‡ [l/s]

Type QL-WE-O/

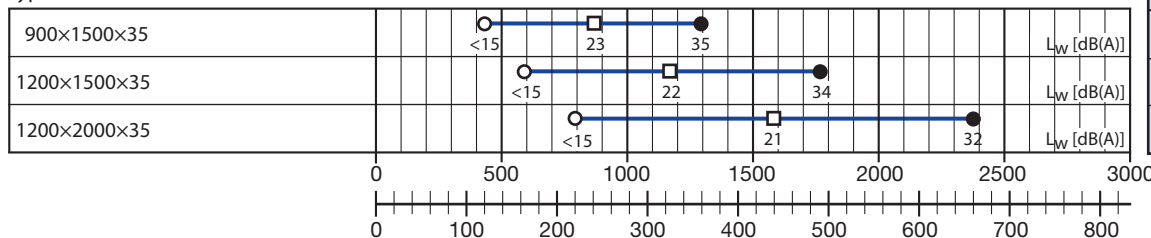

C1 m ³ /h	C2 l/s
281	77.9
401	111.3
568	157.7

‡ [m³/h]

‡ [l/s]

Technical Data

Type QL-WF-EO/

for installation on a wall surface, one way discharge, also available with base

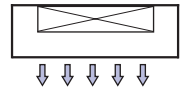
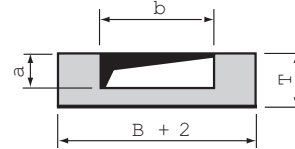
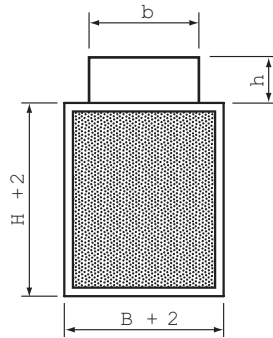
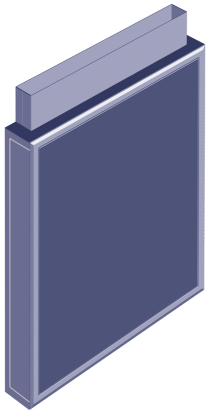

Dimensions Type QL-WF-EO/	B [mm]	H [mm]	T [mm]	b [mm]	a [mm]	h [mm]	Weight ca. [kg]
600x 300x 75-300x 45	600	300	75	298	43	100	6
600x 500x 75-450x 45	600	500	75	448	43	100	9
600x 700x115-400x 90	600	700	115	398	88	100	13
600x1000x115-450x 90	600	1000	115	448	88	100	18
900x1200x125-650x100	900	1200	125	648	98	100	31
1200x1200x125-900x100	1200	1200	125	898	98	100	41
900x1500x150-800x125	900	1500	150	798	123	100	39
1200x1500x150-900x125	1200	1500	150	898	123	100	51
1200x2000x200-900x160	1200	2000	200	898	158	100	67

Other dimensions on request.



B max = 1'200 mm H max = 2'000 mm
B max = 2'000 mm H max = 1'200 mm

Quick selection

Type QL-WF-EO/

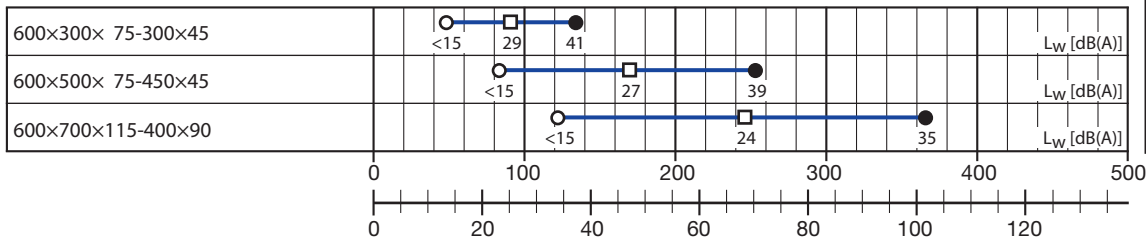

C1 m³/h	C2 l/s
26	7.3
48	13.4
83	23.0

Type QL-WF-EO/

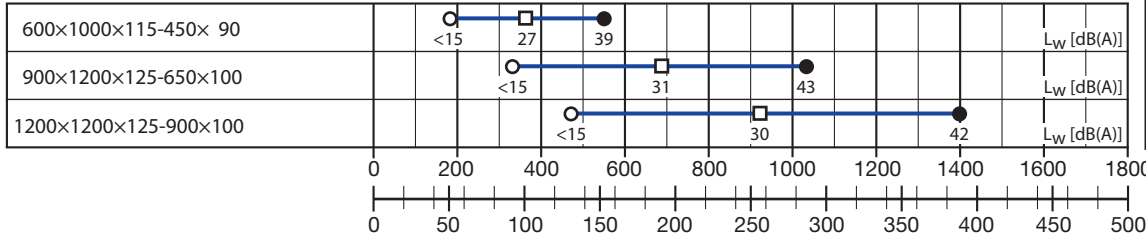

C1 m³/h	C2 l/s
102	28.4
173	48.1
243	67.5

Type QL-WF-EO/

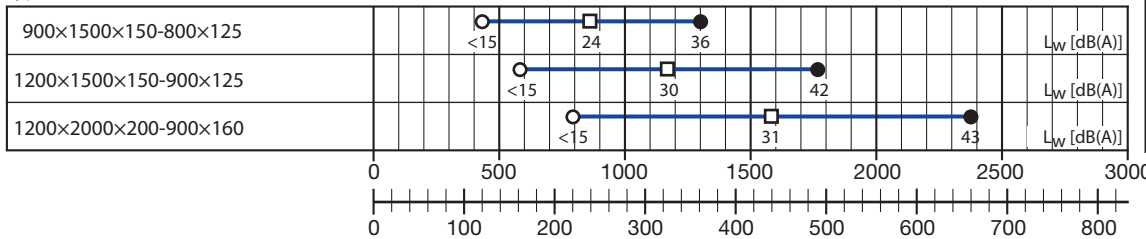

C1 m³/h	C2 l/s
269	74.7
305	84.7
399	110.7

Technical Data

Type QL-WF-RO/

for installation on a wall surface, one way discharge, also available with base

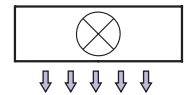
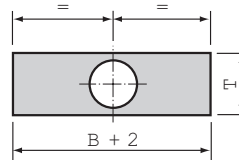
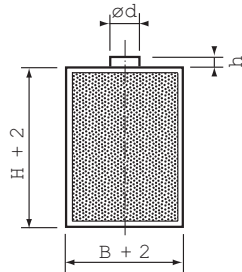
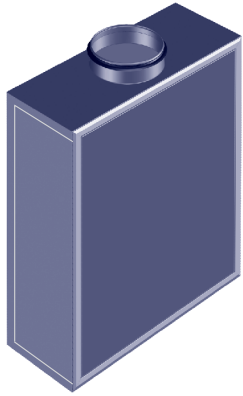

Dimensions Type QL-WF-RO/	B [mm]	H [mm]	T [mm]	Ød [mm]	h [mm]	Weight ca. [kg]
600× 300×160-1×125	600	300	160	123	60	8
600× 500×200-1×160	600	500	200	158	60	12
600× 700×250-1×200	600	700	250	198	60	16
600×1000×300-1×250	600	1000	300	248	60	24

Other dimensions on request.



B max = 1'000 mm H max = 1'000 mm

Quick selection

Type QL-WF-RO/

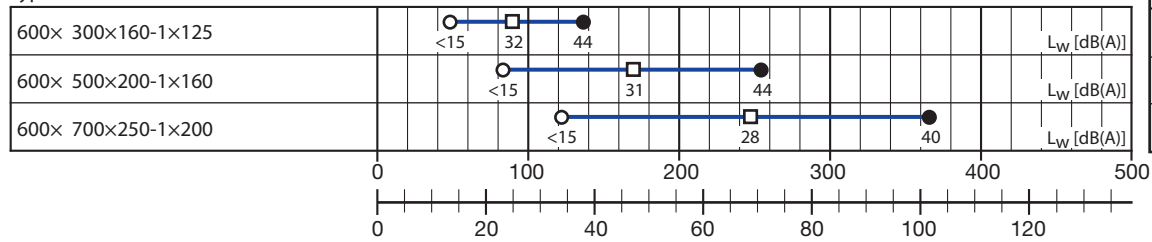

C1 m³/h	C2 l/s
22	6.1
41	11.4
67	18.5

Type QL-WF-RO/

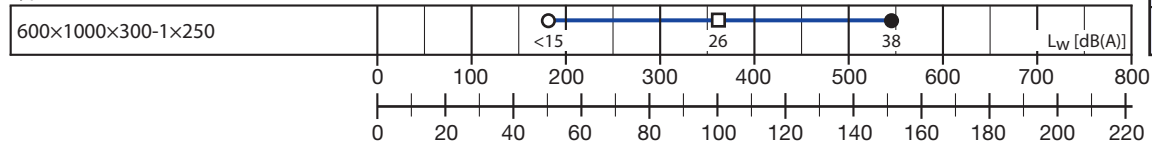

C1 m³/h	C2 l/s
108	30.1

Technical Data

Type QL-WR-RO/

circular unit for free standing installation without duct cover, also available with base

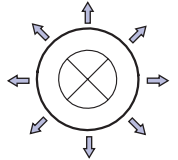
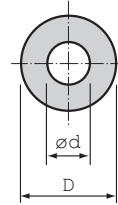
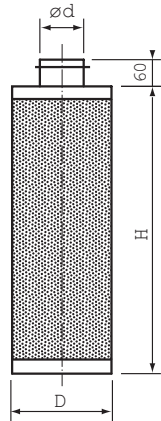

Dimensions Type QL-WR-RO/	D [mm]	H [mm]	Ød [mm]	h [mm]	Weight ca. [kg]
200× 600-1×160	200	600	158	60	8
250×1000-1×200	250	1000	198	60	11
315×1000-1×250	315	1000	248	60	15
400×1000-1×315	400	1000	313	60	22
400×1500-1×315	400	1500	313	60	27
500×1500-1×400	500	1500	398	60	32
500×2000-1×400	500	2000	398	60	45
630×2000-1×500	630	2000	498	60	60

Other heights on request.

Quick selection

Type QL-WR-RO/

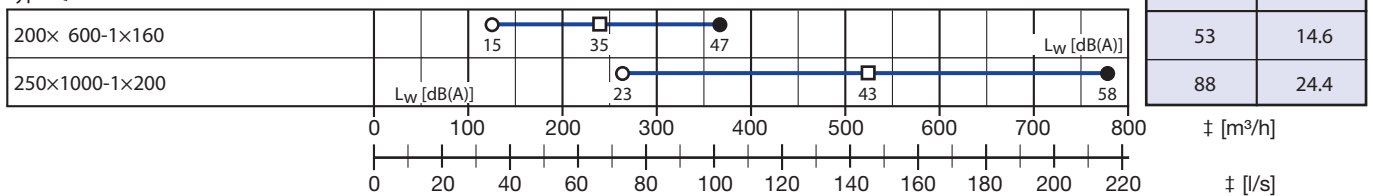

Type QL-WR-RO/

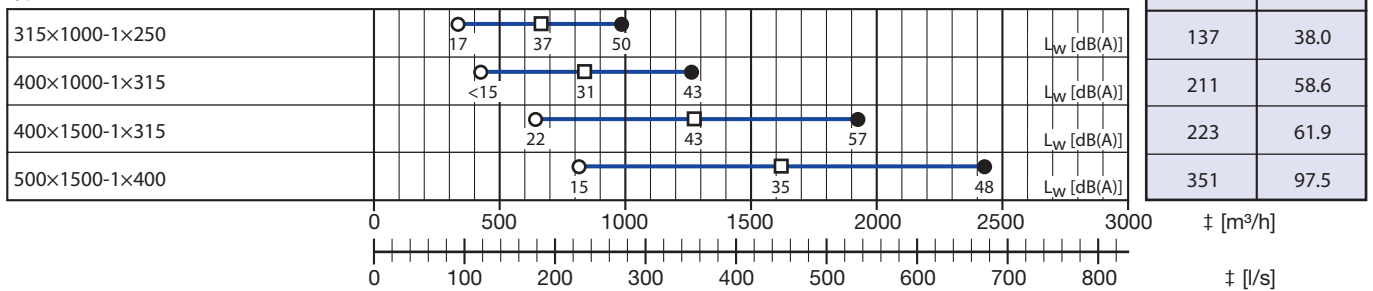

Type QL-WR-RO/

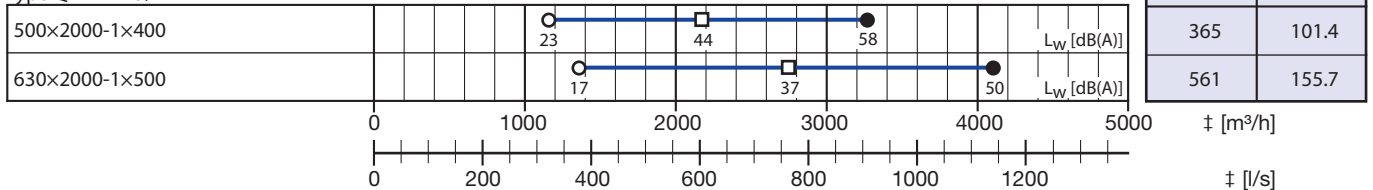

Technical Data

Type QL-WH-RO/

semi circular unit for installation on a wall surface without duct cover, also available with base

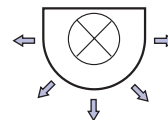
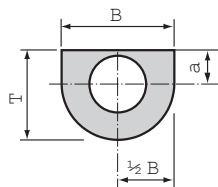
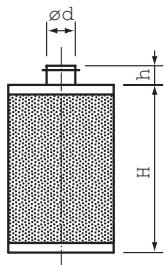

Dimensions Type QL-WH-RO/	B [mm]	H [mm]	T [mm]	Ød [mm]	h [mm]	a [mm]	Weight ca. [kg]
320x 600x190-1x125	320	600	190	123	60	83	7
400x 600x230-1x160	400	600	230	158	60	100	10
350x1000x300-1x200	350	1000	300	198	60	120	15
400x1000x350-1x250	400	1000	350	248	60	145	17
500x1000x450-1x315	500	1000	450	313	60	178	20
500x1500x450-1x315	500	1500	450	313	60	178	27
600x1500x500-1x400	600	1500	500	398	60	220	40
600x2000x500-1x400	600	2000	500	398	60	220	50

Other heights on request.

Quick selection

Type QL-WH-RO/

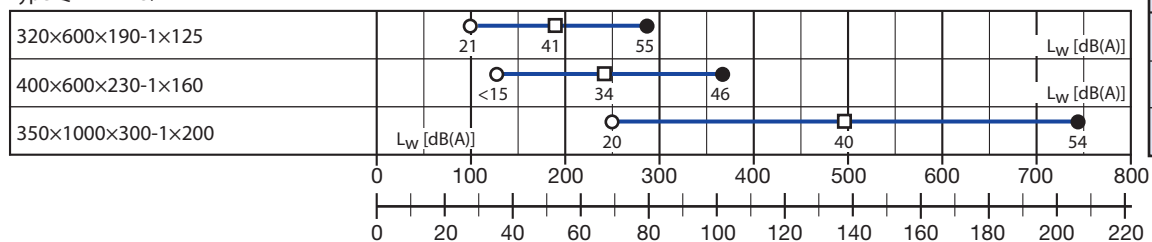

C1 m³/h	C2 l/s
35	9.6
55	15.3
91	25.2

Type QL-WH-RO/

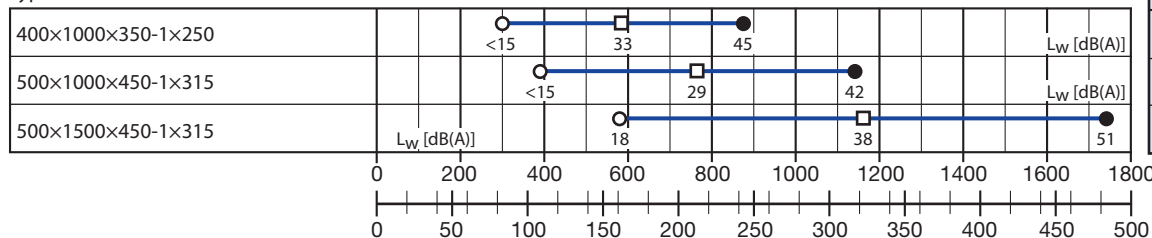

C1 m³/h	C2 l/s
136	37.9
208	57.8
232	64.5

Type QL-WH-RO/

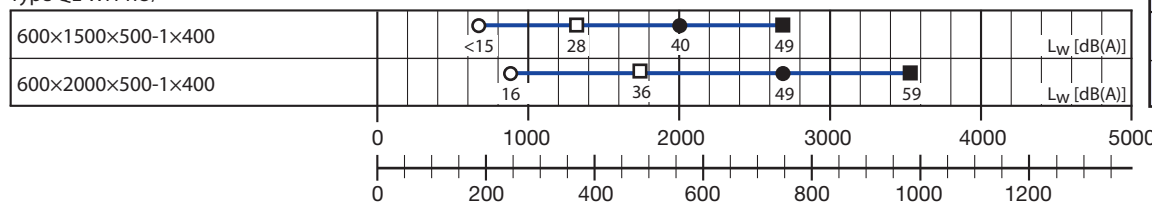

C1 m³/h	C2 l/s
362	100.4
378	105.0

Technical Data

Type QL-WH-RO/.../K

semi circular for installation on a wall surface with duct cover, also available with base

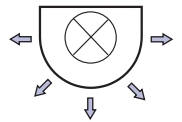
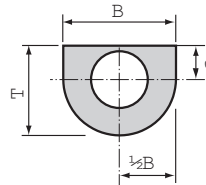
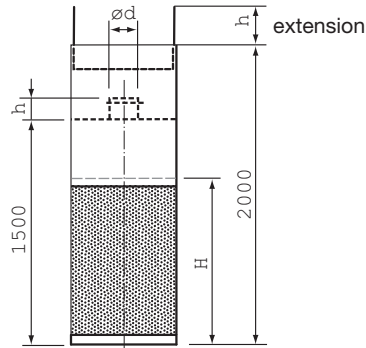

Dimensions Type QL-WH-RO/.../K	B [mm]	H [mm]	T [mm]	Ød [mm]	h [mm]	a [mm]	Weight* ca. [kg]
320x 600x190-1x125/K..	320	600	190	123	60	83	14
400x 600x230-1x160/K..	400	600	230	158	60	100	20
350x1000x300-1x200/K..	350	1000	300	198	60	120	22
400x1000x350-1x250/K..	400	1000	350	248	60	145	25
500x1000x450-1x315/K..	500	1000	450	313	60	178	29
500x1500x450-1x315/K..	500	1500	450	313	60	178	39
600x1500x500-1x400/K..	600	1500	500	398	60	220	58

Other heights on request.

*without extension

Quick selection

Type QL-WH-RO/.../K

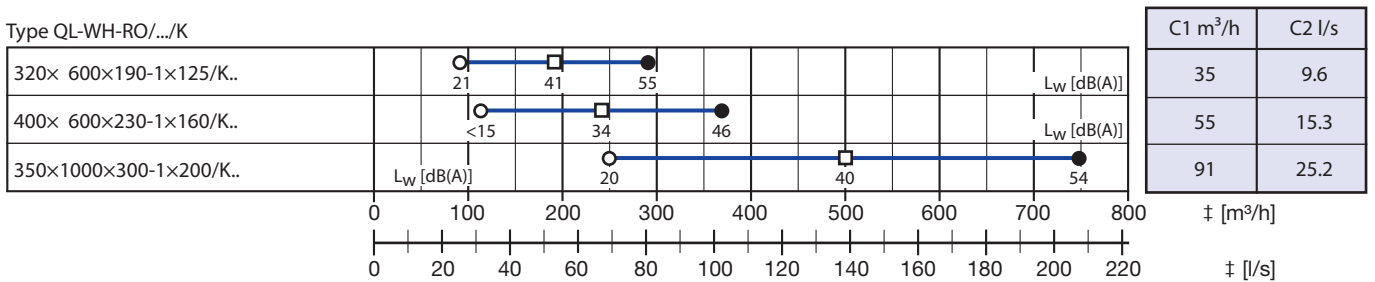

Type QL-WH-RO/.../K

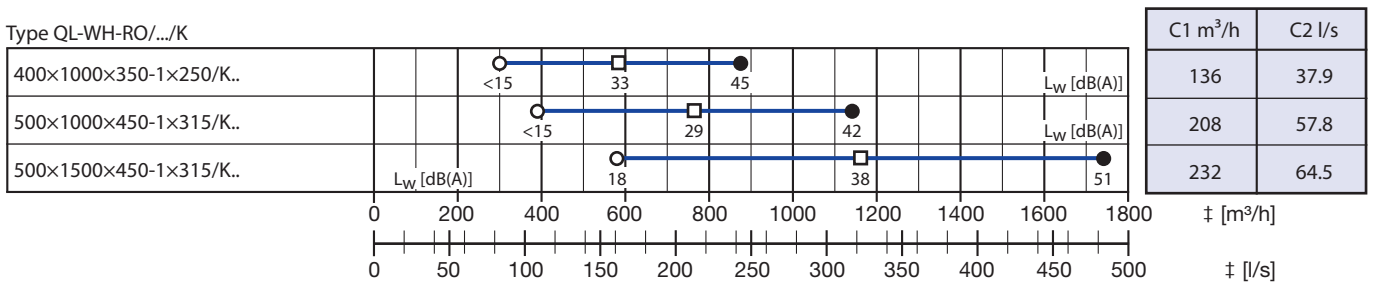

Type QL-WH-RO/.../K

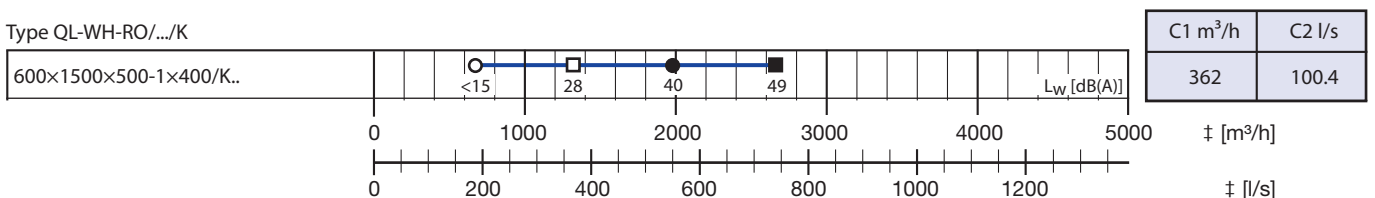

Technical Data

Type QL-WV-RO/

quarter-round for installation in a wall corner without duct cover, also available with base

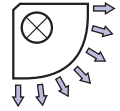
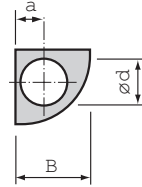
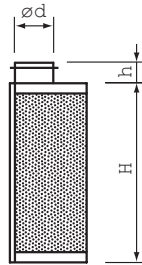

Dimensions Type QL-WV-RO/	B [mm]	H [mm]	Ød [mm]	h [mm]	a [mm]	Weight ca. [kg]
190× 600×190-1×125	190	600	123	60	75	6
225× 600×225-1×160	225	600	158	60	90	9
300×1000×300-1×200	300	1000	198	60	125	12
340×1000×340-1×250	340	1000	248	60	137	14
450×1500×450-1×315	450	1500	313	60	180	18

Other heights on request.

Quick selection

Type QL-WV-RO/

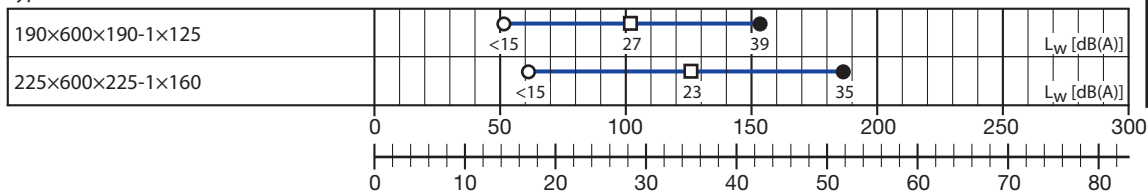

C1 m³/h	C2 l/s
29	8.1
45	12.6

Type QL-WV-RO/

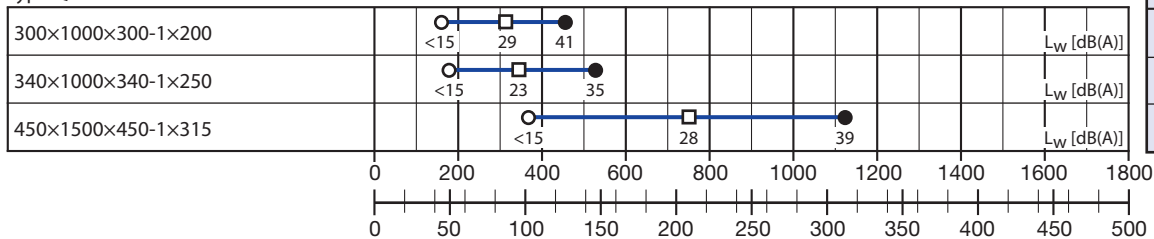

C1 m³/h	C2 l/s
80	22.2
120	33.3
206	57.2

Technical Data

Type QL-WV-RO/.../K

quarter-round for installation in a wall corner with a duct cover, also available with base

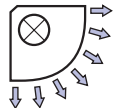
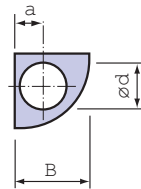
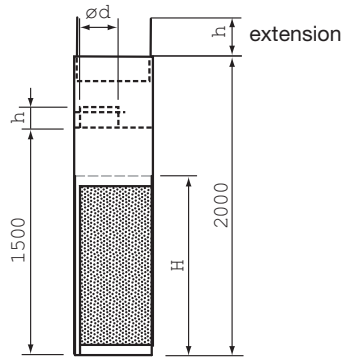

Dimensions Type QL-WV-RO/.../K	B [mm]	H [mm]	Ød [mm]	h [mm]	a [mm]	Weight* ca. [kg]
190× 600×190-1×125/K..	190	600	123	60	75	16
225× 600×225-1×160/K..	225	600	158	60	90	18
300×1000×300-1×200/K..	300	1000	198	60	125	19
340×1000×340-1×250/K..	340	1000	248	60	137	21
450×1500×450-1×315/K..	450	1500	313	60	180	22

Other heights on request.

*without extension

Quick selection

Type QL-WV-RO/.../K

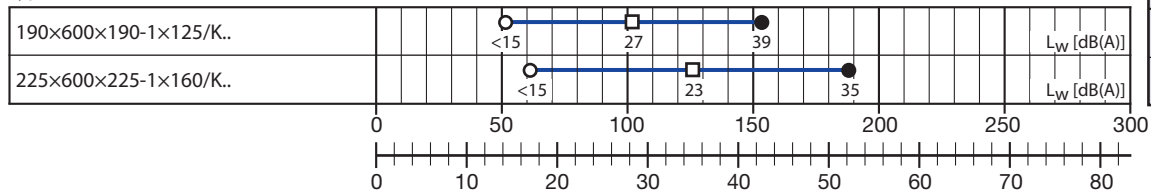

C1 m³/h	C2 l/s
29	8.1
45	12.6

Type QL-WV-RO/.../K

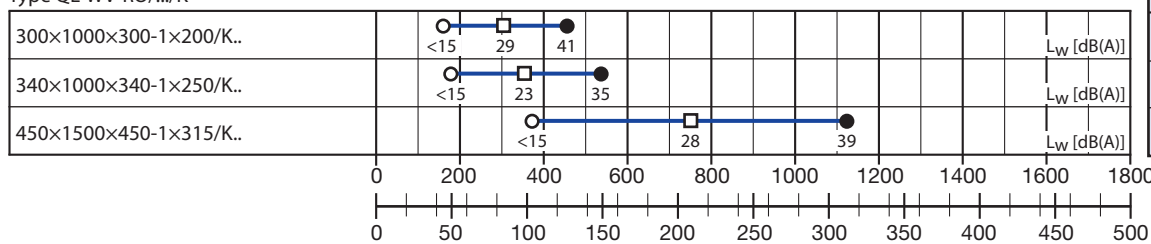

C1 m³/h	C2 l/s
80	22.2
120	33.3
206	57.2

Technical Data

Type QL-WS-RO/.../K

segment shaped unit for installation on a wall surface with a duct cover, also available with base

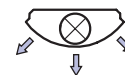
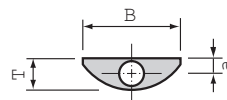
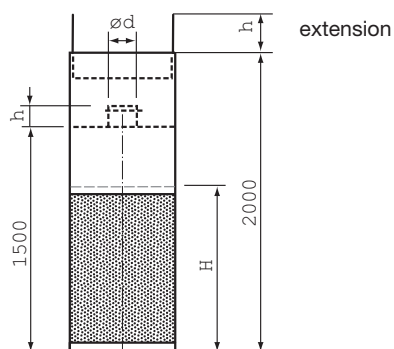

Dimensions Type QL-WS-RO/.../K	B [mm]	H [mm]	T [mm]	Ød [mm]	h [mm]	a [mm]	Weight* ca. [kg]
400×1000×155-1×100/K..	400	1000	155	98	60	70	17
500×1000×175-1×125/K..	500	1000	175	123	60	85	20
600×1000×215-1×160/K..	600	1000	215	158	60	105	24
750×1000×255-1×200/K..	750	1000	255	198	60	125	32

*without extension

Quick selection

Type QL-WS-RO/.../K

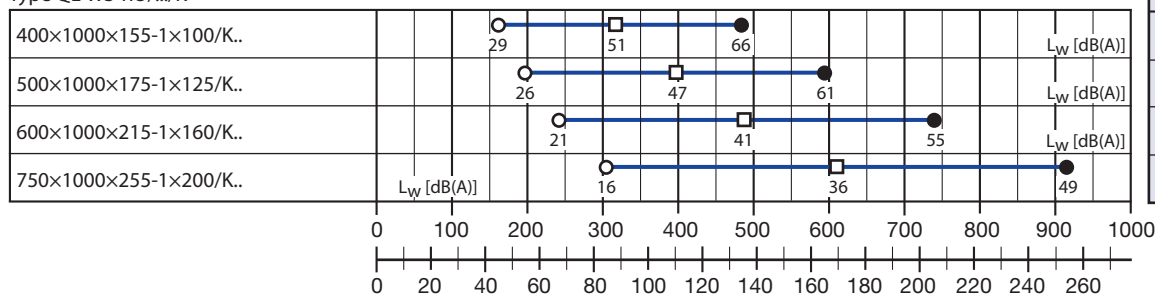

C1 m³/h	C2 l/s
44	12.2
61	16.9
88	24.6
129	35.8

Technical Data

Type QL-BE-RO/

for installation into a false floor

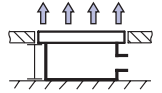
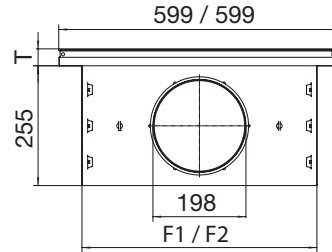
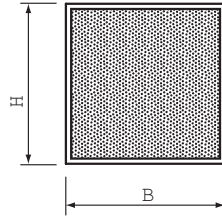
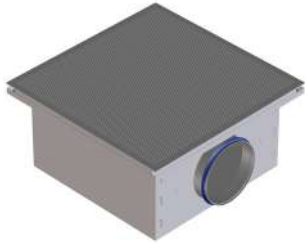

Type QL-BE-RO/	B [mm]	H [mm]	F1 [mm]	F2 [mm]	T [mm]	Weight ca. [kg]
600x600xT-1x200	600	600	500	500	30-40	26

Not available in stainless steel. Standard colour RAL 9011.

Quick selection

Type QL-BE-RO/

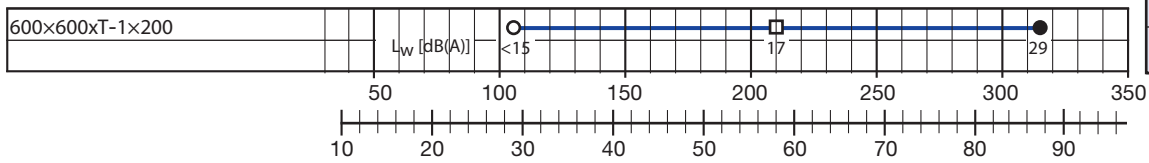

C1 m ³ /h	C2 l/s
86	23.7
‡ [m ³ /h]	‡ [l/s]

Perforation

QL-BE

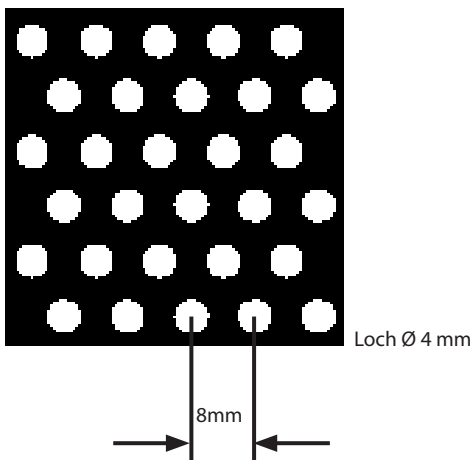

Type QL-BB (continuous floor band)

for use as continuous bands inset into the floor

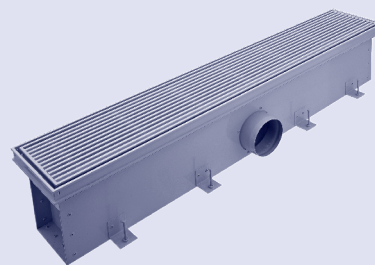

Further information in the continuous floor band brochure (L-08-1-05e).

Type QL-WQT-RO-2/

for installation on a wall surface with trapezoidal face, circular connecting spigot, two way discharge, without base

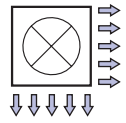
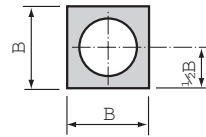
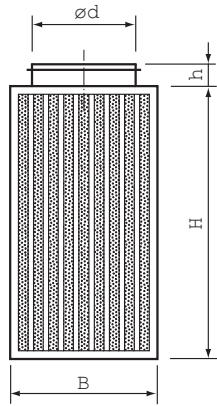
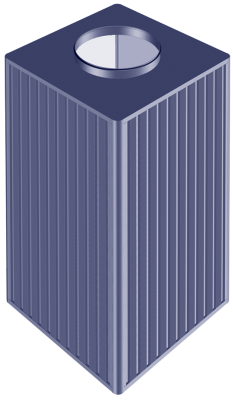

Dimensions Type QL-WQT-RO-2/	B [mm]	H [mm]	Ød [mm]	h [mm]	Weight ca. [kg]
800×2000× 800-1×630	800	2000	628	100	100
1200×2000×1200-1×800	1200	2000	798	100	157

Other dimensions on request.

Quick selection

Type QL-WQT-RO-2/

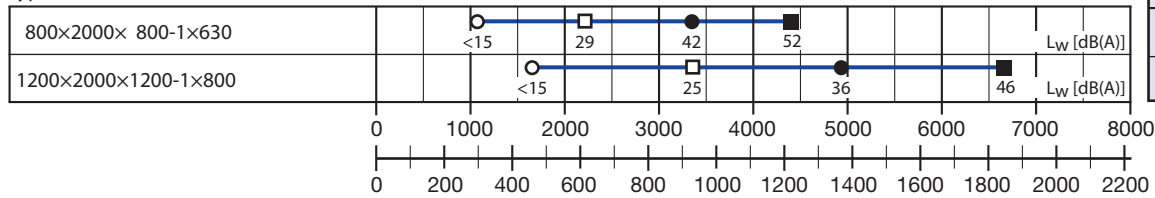

C1 m³/h	C2 l/s
697	193.7
1152	320.1

As standard, non active faces are trapezoidal, not perforated sheet metal and are not painted. Paint finish on all surfaces at extra cost.

Technical Data

Type QL-WQT-RO-3/

for installation on a wall surface with trapezoidal face, circular connecting spigot, three way discharge, without base

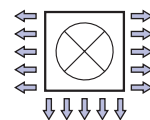
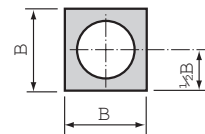
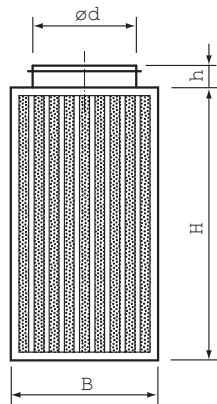
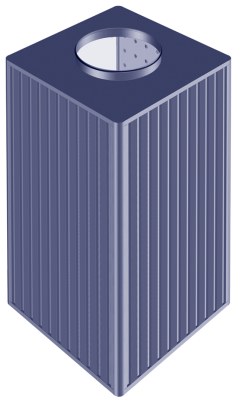

Dimensions Type QL-WQT-RO-3/	B [mm]	H [mm]	Ød [mm]	h [mm]	Weight ca. [kg]
800×2000× 800-1×630	800	2000	628	100	108
1200×2000×1200-1×800	1200	2000	798	100	167

Other dimensions on request.

Quick selection

Type QL-WQT-RO-3/

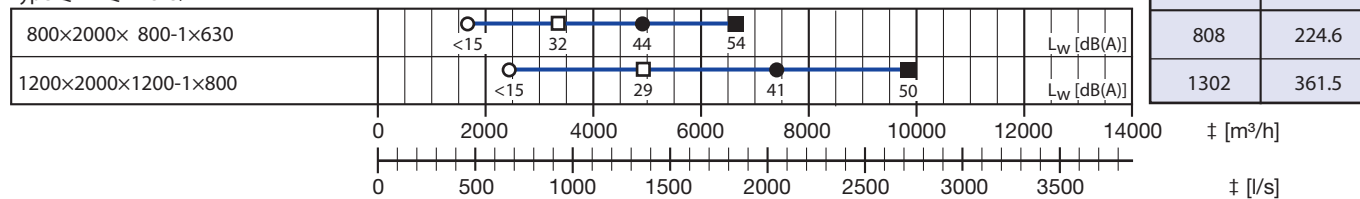

As standard, non active faces are trapezoidal, not perforated sheet metal and are not painted. Paint finish on all surfaces at extra cost.

Type QL-WQT-RO-4/

for free standing installation with trapezoidal face, circular connecting spigot, four way discharge, without base

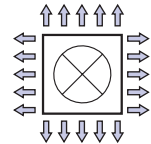
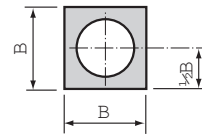
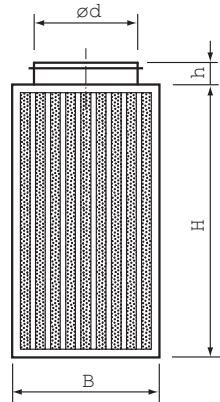
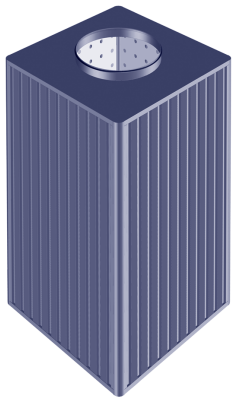

Dimensions Type QL-WQT-RO-4/	B [mm]	H [mm]	Ød [mm]	h [mm]	Weight ca. [kg]
800×2000× 800-1×630	800	2000	628	100	116
1200×2000×1200-1×800	1200	2000	798	100	184

Other dimensions on request.

Quick selection

Type QL-WQT-RO-4/

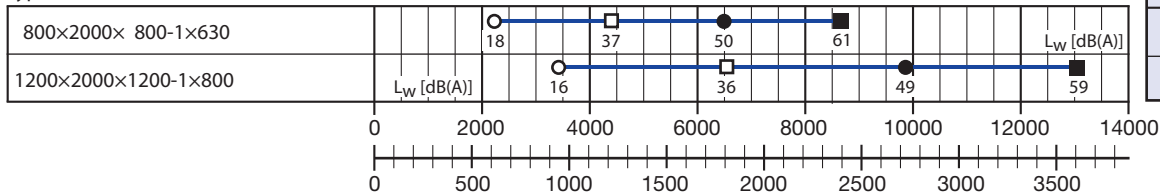

C1 m³/h	C2 l/s
862	239.5
1369	380.3

Technical Data

Type QL-WFM-EO-0/; Type QL-WFM-EO-2L/; Type QL-WFM-EO-2R/; Type QL-WFM-EO-3/
for installation on a wall surface, rectangular connecting spigot, also available with base

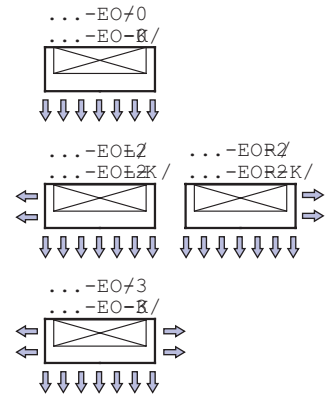
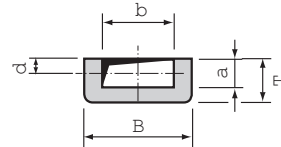
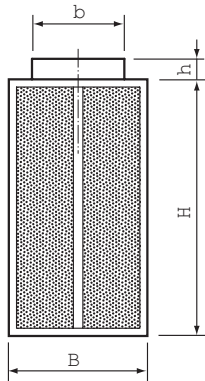

QL-WFM-EO-0/; QL-WFM-EO-2L/; QL-WFM-EO-2R/; QL-WFM-EO-3/	B [mm]	H [mm]	T [mm]	b [mm]	a [mm]	h [mm]	d [mm]	Weight ca. [kg]
600×2000×270-420×220	600	2000	270	418	218	100	110	50
1200×2000×270-900×220	1200	2000	270	898	218	100	110	75
1200×2000×350-900×300	1200	2000	350	898	298	100	150	85

Other dimensions on request.

Quick selection

Type QL-WFM-EO-0/

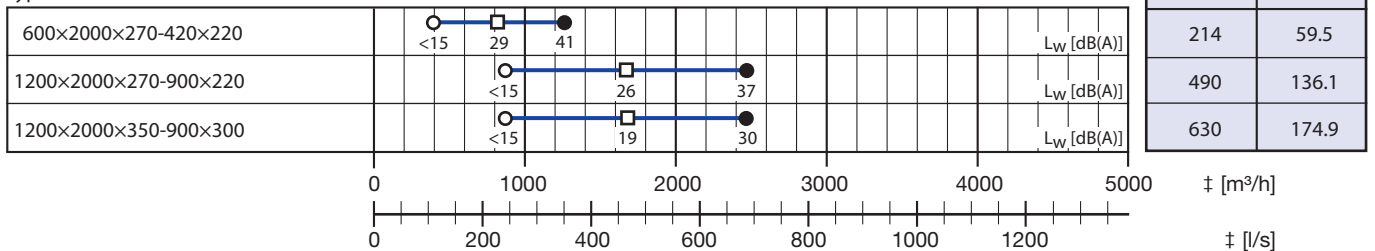

Type QL-WFM-EO-2L/

Type QL-WFM-EO-2R/

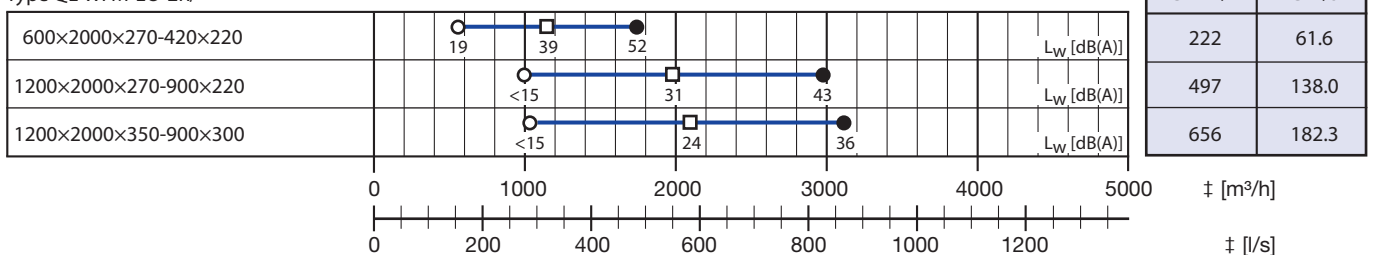

Type QL-WFM-EO-3/

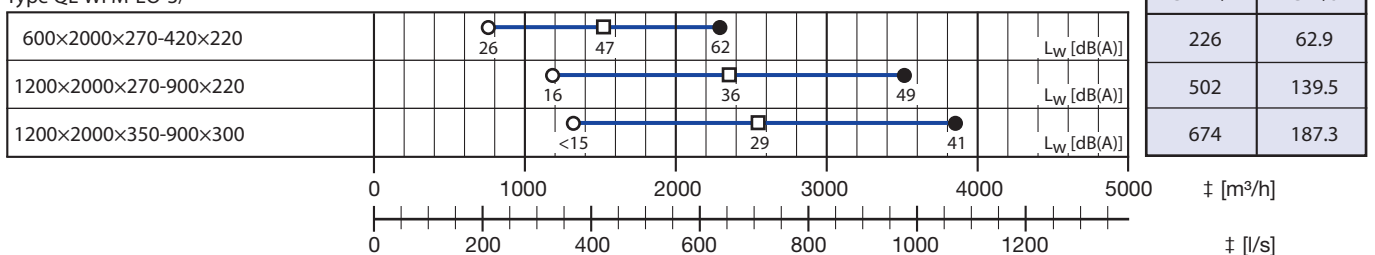

Technical Data

Type QL-WFT-RO/

for installation on a wall surface with trapezoidal face, circular connecting spigot, without base

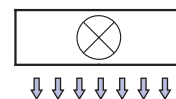
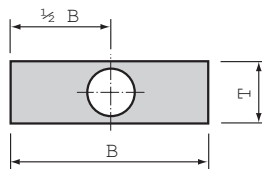
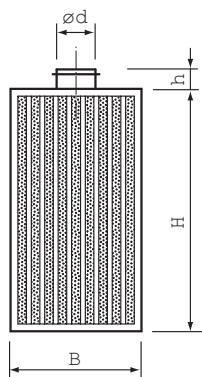
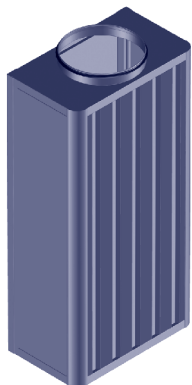

Dimensions Type QL-WFT-RO/	B [mm]	H [mm]	T [mm]	Ød [mm]	h [mm]	Weight ca. [kg]
600×1200×350-1×250	600	1200	350	248	60	33
600×2000×350-1×315	600	2000	350	313	60	53

Other dimensions on request.

Quick selection

Type QL-WFT-RO/

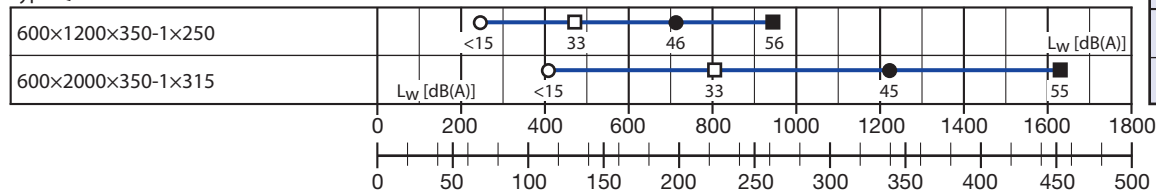

C1 m³/h	C2 l/s
108	30.1
188	52.2

Type QL-WFT-EO/

for installation on a wall surface with trapezoidal face, rectangular connecting spigot, one way discharge, without base

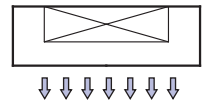
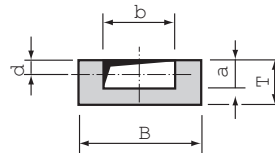
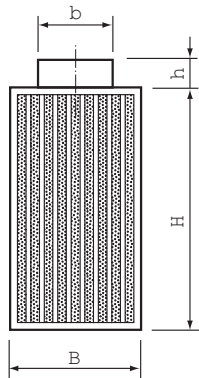
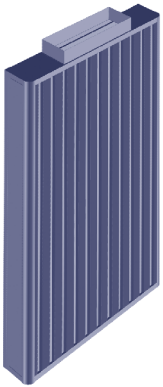

Dimensions Type QL-WFT-EO/	B [mm]	H [mm]	T [mm]	b [mm]	a [mm]	h [mm]	d [mm]	Weight ca. [kg]
1200x2000x220-800x170	1200	2000	220	798	168	100	85	55
1200x2000x350-800x300	1200	2000	350	798	298	100	150	66

Other dimensions on request.

Quick selection

Type QL-WFT-EO/

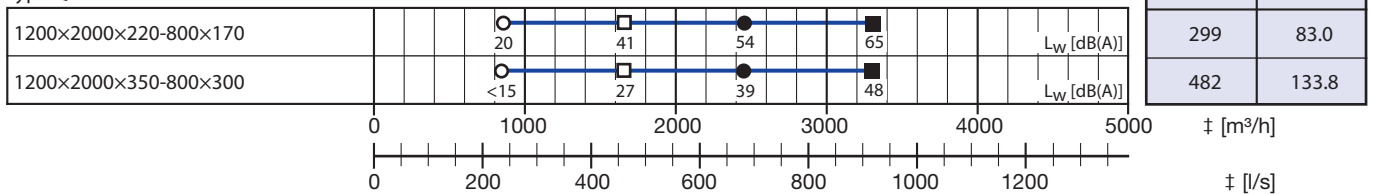

General technical information for the selection of TROX HESCO displacement flow diffusers

Displacement flow is different from mixed flow not only in that the discharge point is no longer in or near the ceiling area but also in that the air movement is driven by the thermal convection generated by users of the space, machines, computers etc. Because the outlets for displacement flow are normally in the occupied zone, the discharge velocities are very low compared to mixed flow. 0,1 to 0,2 m/s in comfort conditioning and up to a maximum of 0,5 m/s in industrial applications or situations where higher levels of activity occur .

The vertical temperature gradient is substantially different from that of mixed flow. While the room temperature with mixed flow is virtually the same from floor to ceiling, there is a clear temperature gradient with displacement flow. Thus Δt has less significance than with mixed flow. The room temperature with displacement flow is defined at any location outside the near zone $L_{0,2}$ at 1 m above the floor. The difference between supply air temperature t_{zL} and room temperature t_R is referred to as Δt_u . Please note for design in situations with mainly sedentary activities e.g. offices and schools, the supply air temperature in the occupied zone should not be less than 18°C and Δt_u 4 to 5K (in extreme cases 6K). For higher levels of activity i.e. standing , walking and industrial applications a Δt_u 5 to 7K (in extreme cases 8K) and a minimum supply air temperature of 16°C are acceptable.

In the interests of thermal comfort it is important that the temperature difference Δt_C (room temperature 1 m above the floor – temperature 0.1 m above the floor) does not exceed 2 K for comfort conditioning and 3 K for industrial applications.

We will be pleased to assist you with the concept and design.

Temperature conditions: Nomenclature

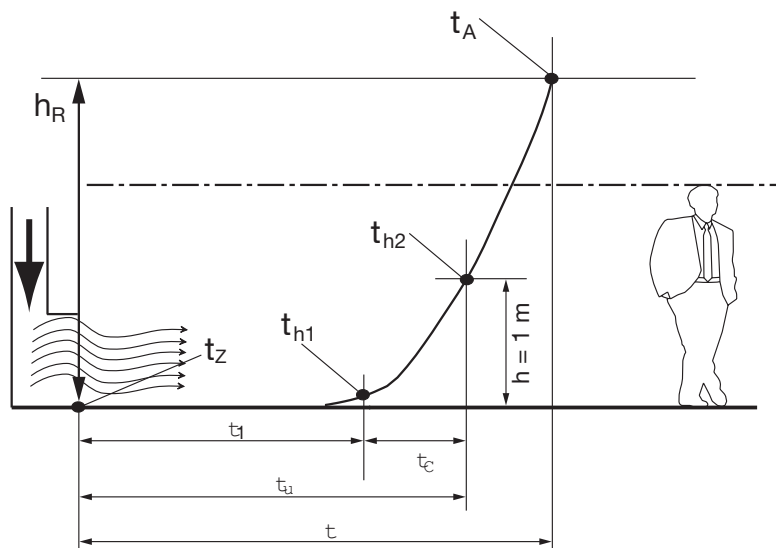

Q	Watt	Heat load
\dot{v}	m^3/h	Supply flow rate
\dot{v}_{m^2}	$\text{m}^3/\text{h}, \text{m}^2$	Supply flow rate per m^2 floor area
ρ	kg/m^3	Air density
c_p	$\text{kJ}/\text{kg}, \text{K}$	Specific heat
h_R	m	Room height
t_z	$^{\circ}\text{C}$	Supply air temperature
t_{h1}	$^{\circ}\text{C}$	Air temperature at approx. 0.1 m above the floor
t_{h2}	$^{\circ}\text{C}$	Room temperature at approx. 1 m above the floor
t_A	$^{\circ}\text{C}$	Extract air temperature
Δt	K	Difference between extract air temperature and supply air temperature
Δt_1	K	Difference between floor air temperature at approx. 0.1 m above the floor and supply air temperature
Δt_u	K	Difference between room temperature and supply air temperature
Δt_C	K	$(t_{h2} - t_{h1})$ Comfort – Temperature difference
$L_{0,2}$	m	Length of near zone Near zone length defines the boundary around the displacement diffuser, within which the air velocity and temperature near the floor are outside normal comfort criteria

Temperature conditions: Comfort conditioning

Determination of the temperature conditions in the room and the flow rate on the basis of the heat load

Air density ρ = 1.20 kg/m³
 Specific heat c_p = 1.004 kJ/kg, K
 Room air temperature t_{h2} at approx. 1 m above floor

Flow rate $\ddagger = \frac{3600 \times Q}{\Delta t \times c_p \times \rho}$ [m³/h]

Δt = extract air temperature - supply air temperature
 Δt_u = room air temperature - supply air temperature
 Δt_1 = floor air temperature - supply air temperature

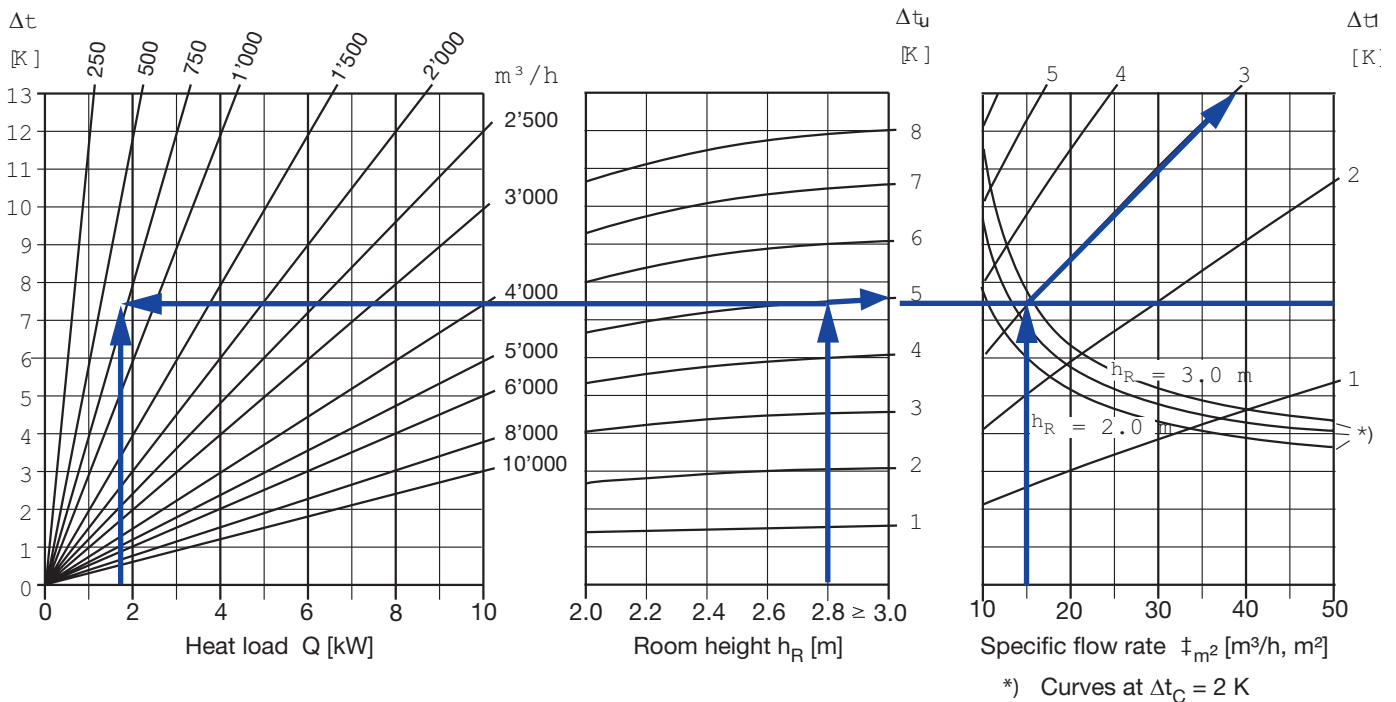

Example:

Given
 Area 48 m² A
 Room height 2.8 m h_R
 Heat load 1.8 kW Q
 Supply air temperature 18°C t_Z
 Room temp. (approx. 1 m above floor) 23°C t_{h2}

Sought

Δt_u Δt t_A \ddagger \ddagger_{m^2} Δt_1 t_{h1} Δt_C

Result

Calculate	1) Δt_u	= $t_R - t_{ZL}$	= 23 - 18	= 5 K
Graph centre	2) Δt	= at h_R 2.8 m and $\Delta t_u = 5$ K		= 7.4 K
Calculate	3) t_A	= $t_Z + \Delta t$	= 18 + 7.4	= 25.4 K
Graph left	4) \ddagger	= at $\Delta t = 7.4$ K and $Q = 1.8$ kW		= 730 m ³ /h
Calculate	5) \ddagger_{m^2}	= 730/48		= 15.2 m ³ /h, m ²
Graph right	6) Δt_1	= at 7.4 K and $\ddagger_{m^2} = 15.2$ m ³ /h, m ²		= 3 K
Calculate	7) t_{h1}	= $t_Z + \Delta t_1$	= 18 + 3	= 21°C
Calculate	8) Δt_C	= $(t_{h2} - t_{h1})$ 23 - 21		= 2 K

Temperature conditions: Industrial applications

Determination of the temperature conditions in the room and the flow rate on the basis of the heat load

Air density ρ = 1.20 kg/m³
 Specific heat c_p = 1.004 kJ/kg,K
 Room air temperature t_{h2} at approx. 1 m above floor

Flow rate $\ddagger = \frac{3600 \times Q}{\Delta t \times c_p \times \rho}$ [m³/h]

Δt = extract air temperature - supply air temperature
 Δt_u = room air temperature - supply air temperature
 Δt_1 = floor air temperature - supply air temperature

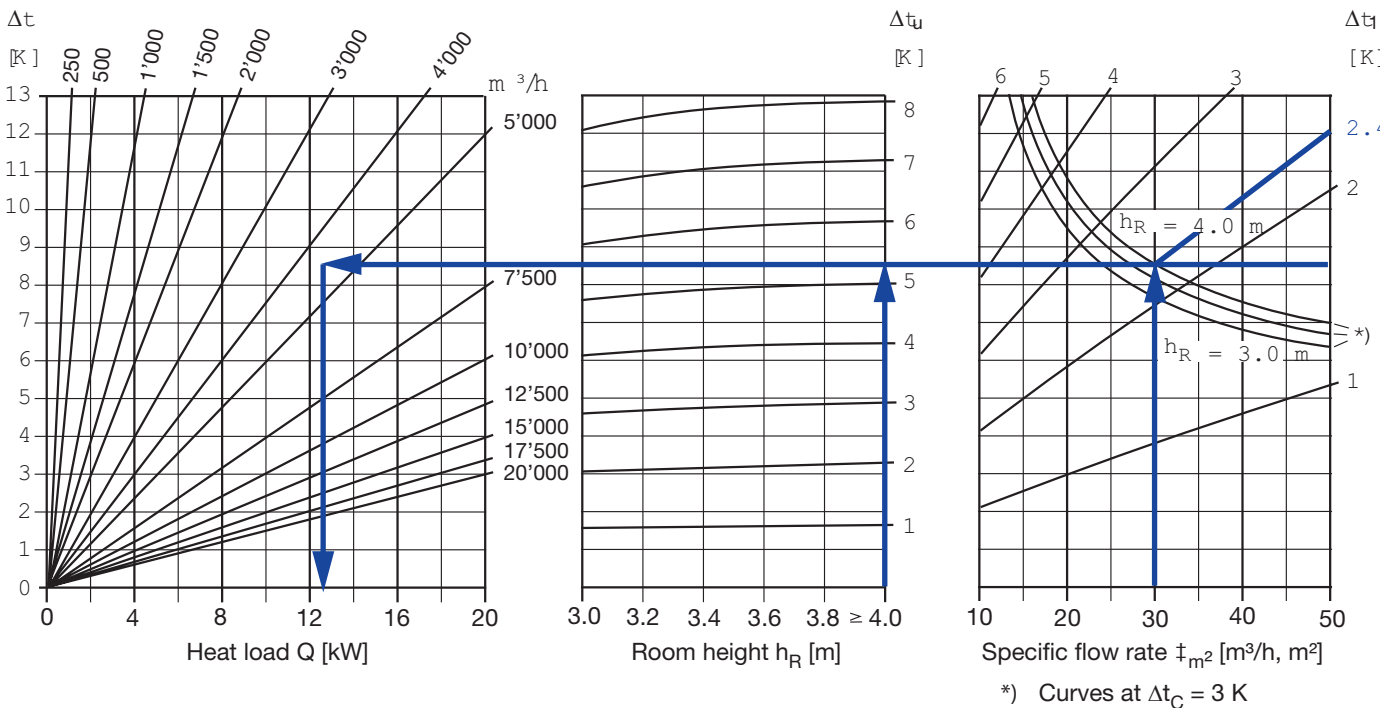

Example:

Given
 Area 150 m² A
 Room height 4.0 m h_R
 Flow rate 4500 m³/h ‡
 Room temp. (approx. 1 m above floor) 24°C t_R
 Δt_C 3 K

Sought

\ddagger_{m^2} Δt_{max} Δt_1 Δt_u t_z t_A t_{h1} Q

Result

Calculate	1)	\ddagger_{m^2}	= 4500/150				= 30 m ³ /h, m ²
Graph right	2)	Δt_{max}	= at 30 m ³ /h, m ² and $\Delta t_C = 3$ K				= 8.4 K
	3)	Δt_1					= 2.3 K
Graph centre	4)	Δt_u	= at $\Delta t = 8.4$ K and h _R = 4.0 m				= 5.3 K
Calculate	5)	t_z	= $t_{h2} - \Delta t_u$	= 24 - 5.3			= 18.7°C
Calculate	6)	t_A	= $t_z + \Delta t$	= 18.7 + 8.4			= 27.1°C
Calculate	7)	t_{h1}	= $t_z + \Delta t_1$	= 18.7 + 2.3			= 21°C
Graph left	8)	Q	= at $\ddagger = 4500$ m ³ /h and $\Delta t = 8.4$ K				= 12.7 kW

Displacement flow - Extent of near zone (not for occupation)

Discharge velocity at terminal	$\Delta t_u = 3 \text{ K}$				$\Delta t_u = 6 \text{ K}$			
	0.1 m/s	0.2 m/s	0.3 m/s	0.4 m/s	0.1 m/s	0.2 m/s	0.3 m/s	0.4 m/s

Type QL-WE-E/

600x 300x 75-300x 45	[m]	0.3	0.6	1.0	1.3	0.5	1.0	1.6	2.1
600x 500x 75-450x 45	[m]	0.4	0.8	1.2	1.6	0.6	1.3	1.9	2.6
600x 700x115-400x 90	[m]	0.5	0.9	1.4	1.8	0.7	1.5	2.2	2.9
600x1000x115-450x 90	[m]	0.5	1.0	1.6	2.1	0.8	1.7	2.5	3.4
900x1200x125-650x100	[m]	0.6	1.3	1.9	2.5	1.0	2.1	3.1	4.1
1200x1200x125-900x100	[m]	0.7	1.4	2.1	2.8	1.1	2.2	3.4	4.5
900x1500x150-800x125	[m]	0.7	1.4	2.1	2.8	1.1	2.2	3.4	4.5
1200x1500x150-900x125	[m]	0.8	1.5	2.3	3.0	1.2	2.4	3.7	4.9
1200x2000x200-900x160	[m]	0.8	1.7	2.5	3.4	1.4	2.7	4.1	5.5

Type QL-WE-RO/

600x 300x160-1x125	[m]	0.3	0.6	1.0	1.3	0.5	1.0	1.6	2.1
600x 500x200-1x160	[m]	0.4	0.8	1.2	1.6	0.6	1.3	1.9	2.6
600x 700x250-1x200	[m]	0.5	0.9	1.4	1.8	0.7	1.5	2.2	2.9
600x1000x300-1x250	[m]	0.5	1.0	1.6	2.1	0.8	1.7	2.5	3.4
900x1200x300-2x250	[m]	0.6	1.3	1.9	2.5	1.0	2.1	3.1	4.1
1200x1200x300-2x250	[m]	0.7	1.4	2.1	2.8	1.1	2.2	3.4	4.5
900x1500x300-2x250	[m]	0.7	1.4	2.1	2.8	1.1	2.2	3.4	4.5
1200x1500x350-2x315	[m]	0.8	1.5	2.3	3.0	1.2	2.4	3.7	4.9
1200x2000x350-2x315	[m]	0.8	1.7	2.5	3.4	1.4	2.7	4.1	5.5

Type QL-WE-O/

600x 300x35	[m]	0.3	0.6	1.0	1.3	0.5	1.0	1.6	2.1
600x 500x35	[m]	0.4	0.8	1.2	1.6	0.6	1.3	1.9	2.6
600x 700x35	[m]	0.5	0.9	1.4	1.8	0.7	1.5	2.2	2.9
600x1000x35	[m]	0.5	1.0	1.6	2.1	0.8	1.7	2.5	3.4
900x1200x35	[m]	0.6	1.3	1.9	2.5	1.0	2.1	3.1	4.1
1200x1200x35	[m]	0.7	1.4	2.1	2.8	1.1	2.2	3.4	4.5
900x1500x35	[m]	0.7	1.4	2.1	2.8	1.1	2.2	3.4	4.5
1200x1500x35	[m]	0.8	1.5	2.3	3.0	1.2	2.4	3.7	4.9
1200x2000x35	[m]	0.8	1.7	2.5	3.4	1.4	2.7	4.1	5.5

Type QL-WF-EO/

600x 300x 75-300x 45	[m]	0.3	0.6	1.0	1.3	0.5	1.0	1.6	2.1
600x 500x 75-450x 45	[m]	0.4	0.8	1.2	1.6	0.6	1.3	1.9	2.6
600x 700x115-400x 90	[m]	0.5	0.9	1.4	1.8	0.7	1.5	2.2	2.9
600x1000x115-450x 90	[m]	0.5	1.0	1.6	2.1	0.8	1.7	2.5	3.4
900x1200x125-650x100	[m]	0.6	1.3	1.9	2.5	1.0	2.1	3.1	4.1
1200x1200x125-900x100	[m]	0.7	1.4	2.1	2.8	1.1	2.2	3.4	4.5
900x1500x150-800x125	[m]	0.7	1.4	2.1	2.8	1.1	2.2	3.4	4.5
1200x1500x150-900x125	[m]	0.8	1.5	2.3	3.0	1.2	2.4	3.7	4.9
1200x2000x200-900x160	[m]	0.8	1.7	2.5	3.4	1.4	2.7	4.1	5.5

Type QL-WF-RO/

600x 300x160-1x125	[m]	0.3	0.6	1.0	1.3	0.5	1.0	1.6	2.1
600x 500x200-1x160	[m]	0.4	0.8	1.2	1.6	0.6	1.3	1.9	2.6
600x 700x250-1x200	[m]	0.5	0.9	1.4	1.8	0.7	1.5	2.2	2.9
600x1000x300-1x250	[m]	0.5	1.0	1.6	2.1	0.8	1.7	2.5	3.4

Type QL-BE-RO/

600x600-1x200	[m]	0.3	0.6	0.8	1.1	0.5	0.9	1.4	1.8
---------------	-----	-----	-----	-----	-----	-----	-----	-----	-----

Displacement flow - Extent of near zone (not for occupation)

Discharge velocity at terminal	$\Delta t_u = 3 \text{ K}$				$\Delta t_u = 6 \text{ K}$				
	0.1 m/s	0.2 m/s	0.3 m/s	0.4 m/s	0.1 m/s	0.2 m/s	0.3 m/s	0.4 m/s	
Type QL-WR-RO/									
200× 600-1×160	[m]	0.2	0.4	0.6	0.8	0.3	0.7	1.0	1.3
250×1000-1×200	[m]	0.3	0.5	0.8	1.1	0.4	0.9	1.3	1.7
315×1000-1×250	[m]	0.3	0.6	0.8	1.1	0.5	0.9	1.4	1.8
400×1000-1×315	[m]	0.3	0.6	0.9	1.2	0.5	1.0	1.5	2.0
400×1500-1×315	[m]	0.4	0.7	1.1	1.4	0.6	1.2	1.7	2.3
500×1500-1×400	[m]	0.4	0.8	1.1	1.5	0.6	1.2	1.9	2.5
500×2000-1×400	[m]	0.4	0.9	1.3	1.7	0.7	1.4	2.1	2.8
630×2000-1×500	[m]	0.5	0.9	1.4	1.8	0.7	1.5	2.2	3.0

Types QL-WH-RO/ and QL-WH-RO/.../K

320× 600×190-1×125 (/K..)	[m]	0.3	0.5	0.8	1.0	0.4	0.8	1.2	1.6
400× 600×230-1×160 (/K..)	[m]	0.3	0.5	0.8	1.1	0.4	0.9	1.3	1.8
350×1000×300-1×200 (/K..)	[m]	0.3	0.6	1.0	1.3	0.5	1.0	1.5	2.1
400×1000×350-1×250 (/K..)	[m]	0.3	0.7	1.0	1.3	0.5	1.1	1.6	2.2
500×1000×450-1×315 (/K..)	[m]	0.4	0.7	1.1	1.4	0.6	1.1	1.7	2.3
500×1500×450-1×315 (/K..)	[m]	0.4	0.8	1.2	1.7	0.7	1.4	2.0	2.7
600×1500×500-1×400 (/K..)	[m]	0.4	0.9	1.3	1.8	0.7	1.4	2.1	2.9
600×2000×500-1×400	[m]	0.5	1.0	1.5	2.0	0.8	1.6	2.4	3.2

Types QL-WV-RO/ and QL-WV-RO/.../K

190× 600×190-1×125 (/K..)	[m]	0.2	0.5	0.7	1.0	0.4	0.8	1.2	1.6
225× 600×225-1×160 (/K..)	[m]	0.3	0.5	0.8	1.0	0.4	0.8	1.2	1.7
300×1000×300-1×200 (/K..)	[m]	0.3	0.7	1.0	1.4	0.6	1.1	1.7	2.2
340×1000×340-1×250 (/K..)	[m]	0.4	0.7	1.1	1.4	0.6	1.2	1.7	2.3
450×1500×450-1×315 (/K..)	[m]	0.5	0.9	1.4	1.8	0.7	1.5	2.2	3.0

Type QL-WS-RO/.../K

400×1000×155-1×100/K..	[m]	0.4	0.7	1.1	1.5	0.6	1.2	1.8	2.4
500×1000×175-1×125/K..	[m]	0.4	0.8	1.2	1.6	0.6	1.3	1.9	2.6
600×1000×215-1×160/K..	[m]	0.4	0.8	1.3	1.7	0.7	1.4	2.1	2.7
750×1000×255-1×200/K..	[m]	0.5	0.9	1.4	1.8	0.7	1.5	2.2	2.9

Types QL-WFM-EO/, QL-WFM-EO-2/ and QL-WFM-EO-3/

600×2000×270-480×220	[m]	0.5	1.0	1.5	2.0	0.8	1.6	2.4	3.2
1200×2000×270-900×220	[m]	0.6	1.2	1.8	2.4	1.0	2.0	3.0	3.9
1200×2000×350-900×300	[m]	0.6	1.2	1.8	2.4	1.0	2.0	3.0	3.9

Type QL-WFT-RO/

600×1200×350-1×250	[m]	0.6	1.1	1.7	2.2	0.9	1.8	2.7	3.6
600×2000×350-1×315	[m]	0.7	1.4	2.1	2.7	1.1	2.2	3.3	4.5

Type QL-WFT-E/

1200×2000×220-800×170	[m]	0.8	1.7	2.5	3.4	1.4	2.7	4.1	5.5
1200×2000×350-800×300	[m]	0.8	1.7	2.5	3.4	1.4	2.7	4.1	5.5

Type QL-WQT-RO-2/

800×2000× 800-1×630	[m]	0.6	1.2	1.8	2.4	1.0	2.0	3.0	3.9
1200×2000×1200-1×800	[m]	0.7	1.4	2.1	2.7	1.1	2.2	3.3	4.5

Type QL-WQT-RO-3/

800×2000× 800-1×630	[m]	0.5	1.1	1.6	2.2	0.9	1.7	2.6	3.5
1200×2000×1200-1×800	[m]	0.6	1.2	1.8	2.4	1.0	2.0	3.0	3.9

Type QL-WQT-RO-4/

800×2000× 800-1×630	[m]	0.5	1.0	1.5	2.0	0.8	1.6	2.4	3.2
1200×2000×1200-1×800	[m]	0.6	1.1	1.7	2.2	0.9	1.8	2.7	3.6

Displacement flow - Extent of near zone (not for occupation)

Nomenclature

Correction if n-terminals are side by side (flat units only):
extent of near zone for n terminals = near zone for 1 terminal $\times n^{0.3}$

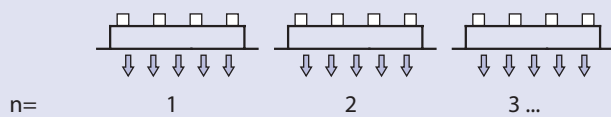

Example Type QL-WF-E/600×1000×115-450×90:

Given	
Width	0.6 m
Height	1.0 m
Flat units only, discharge direction	one way
Number of diffusers side by side	2
Discharge velocity	0.20 m/s
Δt_u	3 K und 5 K

Result	
Near zone from table for 1 unit	1.0 m (3 K) and 1.7 m (6 K)
2 diffusers side by side	$1.0 \times 2^{0.3} = 1.2$ m at 3 K
	$1.7 \times 2^{0.3} = 2.1$ m at 6 K

Flow rate control

QL-xx-Rx-x-M

1. Measure of pressure difference Δp_M

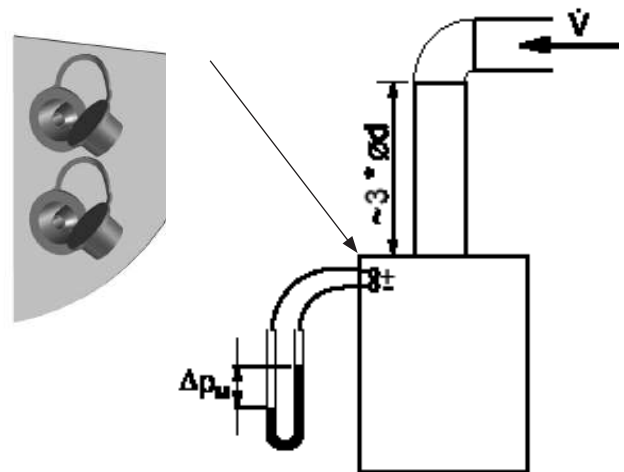

2. Conversion of pressure difference to $\rho = 1.20 \text{ kg/m}^3$

$$\Delta p_{M1.20} = \Delta p_M * \frac{1.20}{\rho_M}$$

3. Specify flow rate \ddagger

Tolerance $\pm 5\%$

$\Delta p_{M1.20}$	Flow rate \ddagger [m ³ /h]								
[Pa]	Ø125	Ø160	Ø200	Ø250	Ø315	Ø400	Ø500	Ø630	Ø800
2	38	68	113	185	306	508	812	1'313	2'148
4	54	98	162	266	439	730	1'166	1'885	3'084
6	67	121	201	329	543	902	1'441	2'329	3'811
8	78	140	233	382	631	1'048	1'674	2'707	4'429
10	88	158	262	429	708	1'178	1'881	3'041	4'978
12	97	173	288	472	779	1'295	2'089	3'345	5'473
14	105	188	312	512	844	1'404	2'243	3'625	5'931
16	112	201	335	549	905	1'505	2'405	3'887	6'360
18	119	214	356	584	963	1'601	2'557	4'133	6'763
20	126	226	376	617	1'017	1'691	2'702	4'367	7'145
25	142	254	423	693	1'143	1'900	3'035	4'907	8'028
30	156	280	465	762	1'257	2'090	3'339	5'397	8'830
35	169	303	504	826	1'362	2'265	3'618	5'849	9'570
40	181	325	540	886	1'461	2'428	3'880	6'271	10'261
45	192	346	575	942	1'553	2'582	4'126	6'689	10'912
50	203	365	607	995	1'641	2'728	4'359	7'046	11'529

$\Delta p_{M1.20}$	Flow rate \ddagger [l/s]								
[Pa]	Ø125	Ø160	Ø200	Ø250	Ø315	Ø400	Ø500	Ø630	Ø800
2	11	19	31	51	85	141	226	365	597
4	15	27	45	74	122	203	324	524	857
6	19	34	58	91	151	251	400	647	1'059
8	22	39	65	106	175	291	465	752	1'230
10	24	44	73	119	197	327	523	845	1'382
12	27	48	80	131	216	360	575	929	1'520
14	29	52	87	142	235	390	623	1'007	1'648
16	31	56	93	152	252	418	668	1'080	1'767
18	33	60	99	162	267	445	710	1'148	1'879
20	35	63	105	171	283	470	750	1'213	1'985
25	39	71	117	192	317	528	843	1'363	2'230
30	43	78	129	212	349	581	927	1'499	2'453
35	47	84	140	229	378	629	1'005	1'625	2'658
40	50	90	150	246	406	675	1'078	1'742	2'850
45	53	96	160	262	432	717	1'146	1'852	3'031
50	56	101	169	276	456	758	1'211	1'957	3'202

Specification texts

General information

TROX HESCO displacement flow diffusers for optimum discharge of conditioned air to the room using the displacement flow principle. Completely uniform velocity profile with special nozzles with integral air deflection scoops.

Type QL-WE-E/ for installation in a wall, one way discharge

Air distribution face plate with integral geometrically arranged plastic nozzles with deflection scoops. Every nozzle provides a constant flow rate from the passing airstream and directs it to the face plate. Perforated flat sheet metal face providing a low-turbulence low velocity discharge, galvanised sheet steel, powder-coated, standard colour white RAL 9010 or RAL colour optional, gloss (see order code). Rectangular connecting spigot.

Type QL-WE-RO/ for installation in a wall, one way discharge

Air distribution face plate with integral geometrically arranged plastic nozzles with deflection scoops. Every nozzle provides a constant flow rate from the passing airstream and directs it to the face plate. Perforated flat sheet metal face providing a low-turbulence low velocity discharge, galvanised sheet steel, powder-coated, standard colour white RAL 9010 or RAL colour optional, gloss (see order code). Circular connecting spigot.

Type QL-WE-O/ for installation in a wall, one way discharge

Air distribution face plate with integral geometrically arranged plastic nozzles with deflection scoops. Every nozzle provides a constant flow rate from the passing airstream and directs it to the face plate. Perforated flat sheet metal face providing a low-turbulence low velocity discharge, galvanised sheet steel, powder-coated, standard colour white RAL 9010 or RAL colour optional, gloss (see order code) Location: installation in a duct or false wall.

Type QL-WF-EO/ and Type QL-WF-RO/ for installation on a wall surface, one way discharge, also available with base and room height duct cover

Air distribution face plate with integral geometrically arranged plastic nozzles with deflection scoops. Every nozzle provides a constant flow rate from the passing airstream and directs it to the face plate. For free standing installation. Compact welded construction. Perforated flat sheet metal face providing a low-turbulence low velocity discharge, galvanised sheet steel, powder-coated, standard colour white RAL 9010 or RAL colour optional, gloss (see order code), rear panel without powder-coating. Rectangular connecting spigot.

Type QL-WF-EO/, rectangular connecting spigot

Type QL-WF-RO/, circular connecting spigot

Options: base and/or duct cover.

Type QL-BE-RO/ for installation in false floors

Air distribution plate, with geometrically arranged perforations, built into the connecting box to give equal air distribution to the floorplate. RAL 9011 as standard, Gloss level see Order Code. Perforated floorplate: robust, perforated and reinforced steel floor plate, powder coated according to architect's preference. Load capacity: 200kg over 215 x 215 mm. Connecting box made from galvanised steel sheet.

Type QL-WR-RO/ circular unit for freestanding installation without a duct, also available with base

Air distribution face plate with integral geometrically arranged plastic nozzles with deflection scoops. Every nozzle provides a constant flow rate from the passing airstream and directs it to the face plate. Perforated sheet metal face providing a low-turbulence low velocity discharge, galvanised sheet steel, powder-coated, standard colour white RAL 9010 or RAL colour optional, gloss (see order code). Circular connecting spigot. Base on request.

Type QL-WH-RO/ and Type QL-WH-RO/.../K semi circular unit for installation on a wall surface without a duct, also available with base

Air distribution face plate with integral geometrically arranged plastic nozzles with deflection scoops. Every nozzle provides a constant flow rate from the passing airstream and directs it to the face plate. Perforated sheet metal face providing a low-turbulence low velocity discharge, galvanised sheet steel, powder-coated, standard colour white RAL 9010 or RAL colour optional, gloss (see order code), rear panel without powder-coating. Circular connecting spigot.

Type QL-WH-RO/ without a duct cover

Type QL-WH-RO/.../K0 Height 2000 mm, without extension

Type QL-WH-RO/.../Kx with a duct cover + extension for room heights to max. 3.50 m. Base on request.

Versions with checkered pattern (...K)

The following versions are also available with checkered pattern front panel:

- | | |
|---------------|--------------------|
| - QL-WE-EO-K/ | - QL-WH-RO-K/.../K |
| - QL-WE-RO-K/ | - QL-WV-RO-K/ |
| - QL-WE-O-K/ | - QL-WV-RO-K/.../K |
| - QL-WF-EO-K/ | - QL-WS-RO-K/.../K |
| - QL-WF-RO-K/ | - QL-WFM-EO-K/ |
| - QL-WR-RO-K/ | - QL-WFM-EO-K-2/ |
| - QL-WH-RO-K/ | - QL-WFM-EO-K-3/ |

Type QL-WV-RO/ and Type QL-WV-K-RO/.../K quarter-round unit for installation in a wall corner, also available with base

Air distribution face plate with integral geometrically arranged plastic nozzles with deflection scoops. Every nozzle provides a constant flow rate from the passing airstream and directs it to the face plate. Perforated sheet metal face providing a low-turbulence low velocity discharge, galvanised sheet steel, powder-coated, standard colour white RAL 9010 or RAL colour optional, gloss (see order code), rear panel without powder-coating. Circular connecting spigot.

Type QL-WV-RO/ without a duct cover

Type QL-WV-RO/.../Kx Height 2000 mm, without extension

Type QL-WV-RO/.../Kx with a duct cover + extension for room height to max. 3.50 m. Base on request.

Type QL-WS-RO/.../K segment shaped unit for installation on a wall surface with a duct cover, also available with base

Rear panel with connecting spigot of galvanised sheet steel. Air distribution face plate with integral geometrically arranged plastic nozzles with deflection scoops. Every nozzle provides a constant flow rate from the passing airstream and directs it to the face plate. Perforated sheet metal face providing a low-turbulence low velocity discharge, galvanised sheet steel, powder-coated, standard colour white RAL 9010 or RAL colour optional, gloss (see order code), rear panel without powder-coating. Circular connecting spigot.

Type QL-WS-RO/.../Kx Height 2000 mm, without extension

Type QL-WS-RO/.../Kx with a duct cover + extension for room height to max. 3.50 m. Base on request.

Type QL-WFM-EO-../ for installation on a wall surface, rectangular connecting spigot, also available with base

Air distribution face plate with integral geometrically arranged plastic nozzles with deflection scoops. Every nozzle provides a constant flow rate from the passing airstream and directs it to the face plate. Perforated flat sheet metal face providing a low-turbulence low velocity discharge, galvanised sheet steel, powder-coated, standard colour white RAL 9010 or RAL colour optional, gloss (see order code), rear panel without powder-coating. Face with high-quality finish: aluminium borders and no visible screws. Rectangular connecting spigot. Option with base.

Type QL-WFM-EO/ one way discharge

Type QL-WFM-EO-2/ two way discharge, face and left or right

Type QL-WFM-EO-3/ three way discharge

Type QL-WFT-E/ installation on a wall surface with trapezoidal face, rectangular connecting spigot, one way discharge, without base

Air distribution face plate with integral geometrically arranged plastic nozzles with deflection scoops. Every nozzle provides a constant flow rate from the passing airstream and directs it to the face plate. Perforated face plate of trapezoidal metal sheet providing a low-turbulence low velocity discharge, galvanised sheet steel, powder-coated, standard colour white RAL 9010 or RAL colour optional, gloss (see order code), rear panel without powder-coating. Rectangular connecting duct.

Type QL-WQT-RO-2/ and Type QL-WQT-RO-3/ or square installation on wall with trapezoidal face, circular connecting spigot, two or three way discharge, without base

Air distribution face plate with integral geometrically arranged plastic nozzles with deflection scoops. Every nozzle provides a constant flow rate from the passing airstream and directs it to the face plate. Perforated face plate of trapezoidal metal sheet providing a low-turbulence low velocity discharge, galvanised sheet steel, powder-coated, standard colour white RAL 9010 or RAL colour optional, gloss (see order code). Circular connecting spigot. As standard, non active faces are trapezoidal, not perforated sheet metal and are not painted. Paint finish on all surfaces at extra cost.

Type QL-WQT-RO-4/ for free standing installation with trapezoidal face, circular connecting spigot, four way discharge, without base

Air distribution face plate with integral geometrically arranged plastic nozzles with deflection scoops. Every nozzle provides a constant flow rate from the passing airstream and directs it to the face plate. Perforated face plate of trapezoidal metal sheet providing a low-turbulence low velocity discharge, galvanised sheet steel, powder-coated, standard colour white RAL 9010 or RAL colour optional, gloss (see order code). Circular connecting spigot.

Order details

Order code

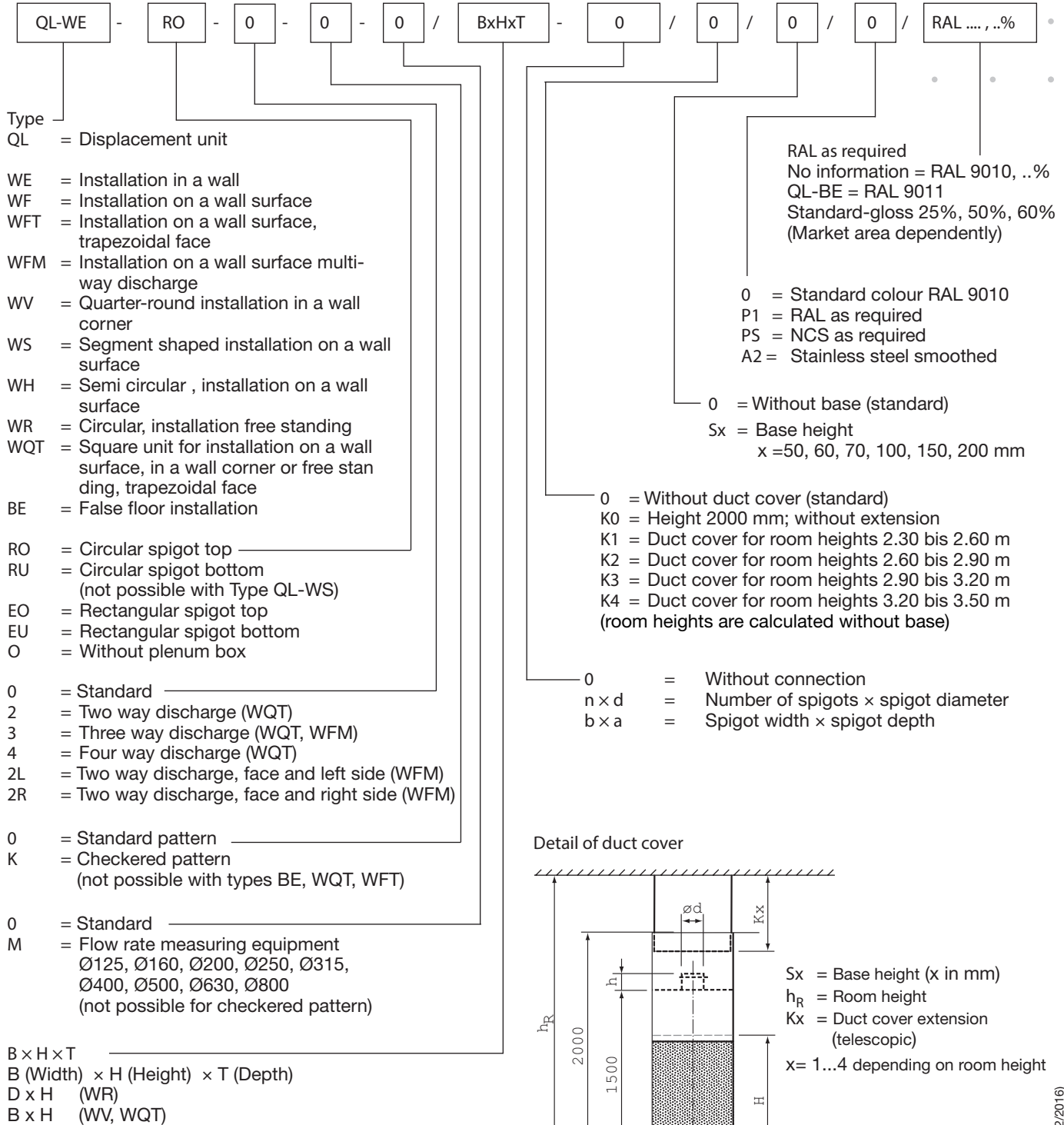

Order examples

15 Stk. QL-WF-EO/600×1000×115-450×90
 24 Stk. QL-WH-RO/400×600×200-1×160/K2
 20 Stk. QL-WE-O/900×1200×35

standard diffusers with rectangular connecting spigots top
 standard diffusers with duct covers for room heights 2.60 to 2.90 m
 standard diffusers without plenum box